

2 The Specifications and Parameters of CPU

This chapter mainly tells the general specifications, performance, external dimension, terminals arrangement and communication interface of the CPU units. For the expansions, please refer to chapter 8.

2-1. Specifications and Parameters

2-2. External Dimension

2-3. Terminals Arrangement

2-4. Communication Interface

2-1. Specifications and Parameters

2-1-1. General Specifications

Items	Specifications
Isolate Voltage	Above DC 500V 2M ohm
Anti-noise	Noise voltage 1000Vp-p 1uS pulse per minute
Atmosphere	No erosive, flammable gas
Ambient Temperature	0°C~60°C
Ambient Humidity	5%~95% (no dew)
COM1 ^{※1}	RS-232, connect with the host machine, HMI to program or debug
COM2 ^{※2}	RS-232/RS-485, connect with net or intelligent instruments, inverters etc.
COM3 ^{※3}	RS-232C/RS-485 expanded by BD card
COM4 ^{※4}	CANBUS COM port
Installation	Use M3 screws or DIN to fix ^{※5}
Grounding	The third type grounding (do not grounding with the strong power system) ^{※6}

※1: All the CPU units have COM1, for program and communication;

※2: 10I/O、14I/O、16I/O CPU units don't have COM2;

※3: COM3 is the COM port from BD card (XC-COM-BD).

※4: COM4 is only equipped on XC series.

※5: The DIN should be DIN46277, width is 35mm.

※6: The grounding should be like type 1 and 2, not 3.

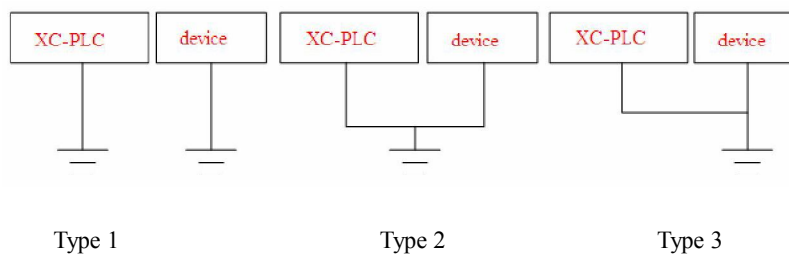

2-1-2. Performance and Specifications

XC1 series

Items		Specifications			
Program Executing Form		Loop scan form			
Program Form		Instruction、Ladder			
Dispose Speed		0.5 us			
Power Off Retentive		Use FlashROM			
User's program space ^{*1}		32K			
I/O points ^{*2}	Total I/O	10	16	24	32
	Input	5 X0~X4	8 X0~X7	12 X0~X13	16 X0~X17
	Output	5 Y0~Y4	8 Y0~Y7	12 Y0~Y13	16 Y0~Y17
Internal Coils (X) ^{*3}		X0~X77 (64)			
Internal Coils (Y) ^{*4}		Y0~Y77 (64)			
Internal Coils (M)		448	M0~M199		
			【M200~M319】 ^{*5}		
			For Special Use ^{*6} M8000~M8079		
			For Special Use ^{*6} M8120~M8139		
			For Special Use ^{*6} M8170~M8172		
			For Special Use ^{*6} M8238~M8242		
		For Special Use ^{*6} M8350~M8370			
Flow (S)		32	S0~S31		
Timer (T)	Points	80	T0~T23: 100ms not accumulate		
			T100~T115: 100ms accumulate		
	T200~T223: 10ms not accumulate				
	T300~T307: 10ms accumulate				
	T400~T403: 1ms not accumulate				
	T500~T503: 1ms accumulate				
	Spec.	100mS timer: set time 0.1~3276.7sec. 10mS timer: set time 0.01~327.67sec. 1mS timer: set time 0.001~32.767sec.			
Counter (C)	Points	48	C0~C23: 16 bits sequential counter		
			C300~C315: 32 bits sequential/inverse counter		
			C600~C603: single phase high speed counter		
			C620~C621		
	C630~C631				
	Spec.	16 bits counter: set value K0~32,767 32 bits counter: set value -2147483648~+2147483647			

Data Register (D)	288 words	D0~D99 【D100~D149】※5
		For Special Use※6D8000~D8029
		For Special Use※6D8060~D8079
		For Special Use※6D8120~D8179
		For Special Use※6D8240~D8249
		For Special Use※6D8306~D8313
		For Special Use※6D8460~D8469
FlashROMRegister (FD)	510 words	FD0~FD411
		For Special Use※6FD8000~FD8011
		For Special Use※6FD8202~FD8229
		For Special Use※6FD8306~FD8315
		For Special Use※6FD8323~FD8335
		For Special Use※6FD8350~FD8384
High Speed Dispose Ability	No	
Password Protection	6 bits ASCII	
Self-diagnose Function	Power on self-check、 monitor the timer、 grammar check	

XC2 Series

Items		Specifications					
Program Executing Form		Loop scan form					
Program Form		Instruction、 Ladder					
Dispose Speed		0.5 us					
Power Off Retentive		Use FlashROM					
User's program space ^{※1}		128K					
I/O points ^{※2}	Total I/O	14	16	24	32	48	60
	Input	8 X0~X7	8 X0~X7	14 X0~X15	18 X0~X21	28 X0~X33	36 X0~X43
	Output	6 Y0~Y5	8 Y0~Y7	10 Y0~Y11	14 Y0~Y15	20 Y0~Y23	24 Y0~Y27
Internal Coils (X) ^{※3}		X0~X777 (512)					
Internal Coils (Y) ^{※4}		Y0~Y777 (512)					
Internal Coils (M)		8768 points	M0~M2999				
			【M3000~M7999】 ^{※5} For Special Use ^{※6} M8000~M8767				
Flow (S)		1024 points	S0~S511 【S512~S1023】				
Timer	points	640 points	T0~T99: 100ms not accumulate				
			T100~T199: 100ms accumulate				
	T200~T299: 10ms not accumulate						
	T300~T399: 10ms accumulate						
	T400~T499: 1ms not accumulate						
	T500~T599: 1ms accumulate						
	T600~T639: 1ms precise time						
	Spec.	100mS timer: set time 0.1~3276.7sec. 10mS timer: set time 0.01~327.67sec. 1mS timer: set time 0.001~32.767sec.					
Counter (C)	points	640 points	C0~C299: 16 bits sequential counter				
			C300~C598: 32 bits sequential/inverse counter				
	C600~C619: single phase high speed counter						
	C620~C629: dual-phase high speed counter						
	C630~C639: AB phase high speed counter						
	Spec.	16 bits counter: set value K0~32,767 32 bits counter: set value -2147483648~+2147483647					
Data Register (D)		2612 Words	D0~D999				
			【D4000~D4999】 ^{※5} For Special Use ^{※6} D8000~D8511				

		For Special Use ^{※6} D8630~D8729
FlashROM Register (FD)	512 words	FD0~FD255
		For Special Use ^{※6} FD8000~FD8255
High Speed Dispose Ability	High speed counter, pulse output, external interruption	
Password Protection	6 bits ASCII	
Self-diagnose Function	Power on self-check、 monitor the timer、 grammar check	

XC3 Series

Items		Specifications				
Program Executing Form		Loop scan form				
Program Form		Instruction、 Ladder				
Dispose Speed		0.5 us				
Power Off Retentive		Use FlashROM and Li battery				
User's program space ^{※1}		128K				
I/O points ^{※2}	Total I/O	14	24	32	48	60
	Input	8 X0~X7	14 X0~X15	18 X0~X21	28 X0~X33	36 X0~X43
	Output	6 Y0~Y5	10 Y0~Y11	14 Y0~Y15	20 Y0~Y23	24 Y0~Y27
Internal Coils (X) ^{※3}		X0~X777 (512)				
Internal Coils (Y) ^{※4}		Y0~Y777 (512)				
Internal Coils (M)		8768 points	M0~M2999			【M3000~M7999】 ^{※5}
			For Special Use ^{※6} M8000~M8767			
Flow (S)		1024 points	S0~S511 【S512~S1023】			
Timer	points	640 points	T0~T99: 100ms not accumulate			
			T100~T199: 100ms accumulate			
			T200~T299: 10ms not accumulate			
			T300~T399: 10ms accumulate			
			T400~T499: 1ms not accumulate			
			T500~T599: 1ms accumulate			
	T600~T639: 1ms precise time					
Spec.		100mS timer: set time 0.1~3276.7sec. 10mS timer: set time 0.01~327.67sec. 1mS timer: set time 0.001~32.767sec.				
Counter (C)	points	640 points	C0~C299: 16 bits sequential counter			
			C300~C598: 32 bits sequential/inverse counter			

		C600~C619: single phase high speed counter
		C620~C629: dual-phase high speed counter
		C630~C639: AB phase high speed counter
	Spec.	16 bits counter: set value K0~32,767 32 bits counter: set value -2147483648~+2147483647
Data Register (D)	9024 words	D0~D3999 【D4000~D7999】 ^{※5} For Special Use ^{※6} D8000~D9023
FlashROM Register (FD)	2048 words	FD0~FD1535 For Special Use ^{※6} FD8000~FD8512
Expansion's Register (ED) ^{※7}	16384 words	ED0~ED16383
High Speed Dispose Ability	High speed counter, pulse output, external interruption	
Password Protection	6 bits ASCII	
Self-diagnose Function	Power on self-check、 monitor the timer、 grammar check	

XC5 Series

Items		Specifications			
Program Executing Form		Loop scan form			
Program Form		Instruction、 Ladder			
Dispose Speed		0.5 us			
Power Off Retentive		Use FlashROM			
User's program space ^{※1}		96K			
I/O points ^{※2}	Total I/O	24	32	48	60
	Input	14 X0~X15	18 X0~X21	28 X0~X33	36 X0~X43
	Output	10 Y0~Y11	14 Y0~Y15	20 Y0~Y23	24 Y0~Y27
Internal Coils (X) ^{※3}		512 points: X0~X777			
Internal Coils (Y) ^{※4}		512 points: Y0~Y777			
Internal Coils (M)	8768 points	M0~M3999 【M4000~M7999】 ^{※5} For Special Use ^{※6} M8000~M8767			
Flow (S)	1024 points	S0~S511 【S512~S1023】			

Timer	points	640 points	T0~T99: 100ms not accumulate
			T100~T199: 100ms accumulate
			T200~T299: 10ms not accumulate
			T300~T399: 10ms accumulate
			T400~T499: 1ms not accumulate
			T500~T599: 1ms accumulate
			T600~T639: 1ms precise time
Spec.	100mS timer: set time 0.1~3276.7sec. 10mS timer: set time 0.01~327.67sec. 1mS timer: set time 0.001~32.767sec.		
Counter (C)	points	640 points	C0~C299: 16 bits sequential counter
			C300~C598: 32 bits sequential/inverse counter
			C600~C619: single phase high speed counter
			C620~C629: dual-phase high speed counter
			C630~C639: AB phase high speed counter
Spec.	16 bits counter: set value K0~32,767 32 bits counter: set value -2147483648~+2147483647		
Data Register (D)	9024 words	D0~D999	
		【D4000~D4999】 ^{*5}	
		For Special Use ^{*6} D8000~D8511 For Special Use ^{*6} D8630~D8729	
FlashROM Register (FD)	6144 words	FD0~FD5119	
		For Special Use ^{*6} FD8000~FD9023	
Expand the internal registers (ED) ^{*7}	36864 words	ED0~ED36863	
High Speed Dispose Ability	High speed counter, pulse output, external interruption		
Password Protection	6 bits ASCII		
Self-diagnose Function	Power on self-check、 monitor the timer、 grammar check		

XCM Series

Items		Specifications		
Program Executing Form		Loop scan form		
Program Form		Instruction、 Ladder		
Dispose Speed		0.5 us		
Power Off Retentive		Use FlashROM and Li battery		
User's program space ^{*1}		160K		
I/O points	Total I/O	24	32	48

※2	Input	14 X0~X015	18 X0~X021	28 X0~X33
	Output	10 Y0~Y011	14 Y0~Y015	20 Y0~Y23
Internal Coils (X) ※3		X0~X1037 (Total 544)		
Internal Coils (Y) ※4		Y0~Y1037 (Total 544)		
Internal Coils (M)		8768 points	M0~M2999	
			【M3000~M7999】 ※5 For Special Use ※6 M8000~M8768	
Flow (S)		1024 points	S0~S511 【S512~S1023】	
Timer	points	640 points	T0~T99: 100ms not accumulate	
			T100~T199: 100ms accumulate	
			T200~T299: 10ms not accumulate	
			T300~T399: 10ms accumulate	
			T400~T499: 1ms not accumulate	
			T500~T599: 1ms accumulate	
	T600~T639: 1ms precise time			
Spec.	100mS timer: set time 0.1~3276.7sec. 10mS timer: set time 0.01~327.67sec. 1mS timer: set time 0.001~32.767sec.			
Counter (C)	points	640 points	C0~C299: 16 bits sequential counter	
			C300~C598: 32 bits sequential/inverse counter	
			C600~C619: single phase high speed counter	
			C620~C629: dual-phase high speed counter	
	C630~C639: AB phase high speed counter			
Spec.	16 bits counter: set value K0~32,767 32 bits counter: set value -2147483648~+2147483647			
Data Register (D)		5024 words	D0~D2999	
			【D4000~D4999】 ※5 For Special Use ※6 D8000~D9023	
		524 words	FD0~FD63	
			For Special Use ※6 FD8000~FD8349	
			For Special Use ※6 FD8890~FD8999	
Expand the internal registers (ED) ※7		36864 words	ED0~ED36863	
High Speed Dispose Ability		High speed counter, pulse output, external interruption		
Password Protection		6 bits ASCII		
Self-diagnose Function		Power on self-check、 monitor the timer、 grammar check		

※1: the user's program space: refer to the maximum program space when download secretly.

- ※2: I/O points: refer to the terminal number that users can connect from outside
- ※3: X: refer to the internal input relays, users can use middle relay when exceed the Input points
- ※4: Y: refer to the internal output relays, users can use middle relay when exceed the Output points
- ※5: **■** Sign: the default power off retentive area, this area can be changed
- ※6: For special use: refer to the special usage registers that are occupied by the system, can't be applied for other usage. For details, please refer to Appendix 1;
- ※7: Only the hardware with 3.0 or above version of the CPU units have internal expansion register ED;

2-2. External Dimension

Graph 1

(Unit: mm)

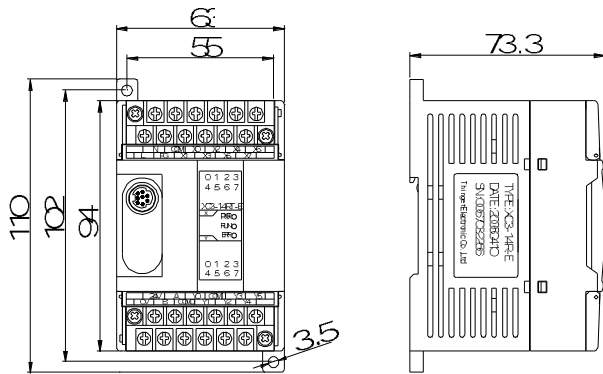

Suitable Model

Series	I/O
XC1	10 and 16
XC2	14 and 16
XC3	14

Graph 2

(Unit: mm)

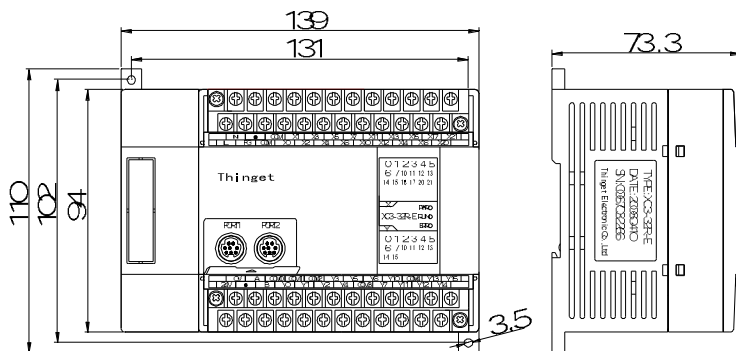

Suitable Model

Series	I/O
XC1	24 and 32
XC2	24 and 32
XC3	24 and 32
XC5	24 and 32
XCM	24 and 32

Graph 3

(Unit: mm)

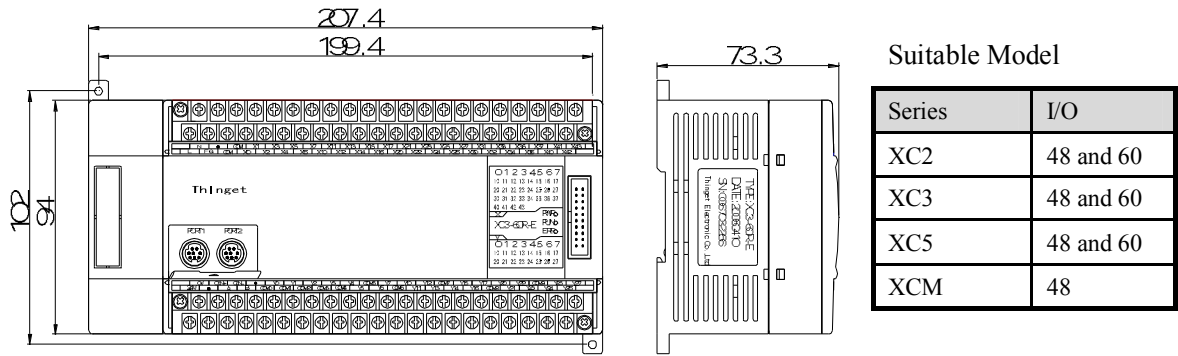

2-3. Terminals Arrangement

● Graph A

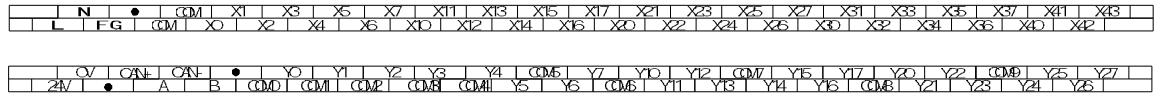

● Graph B

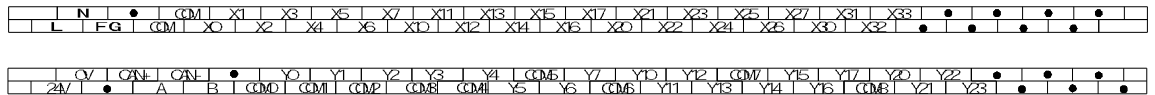

● Graph C

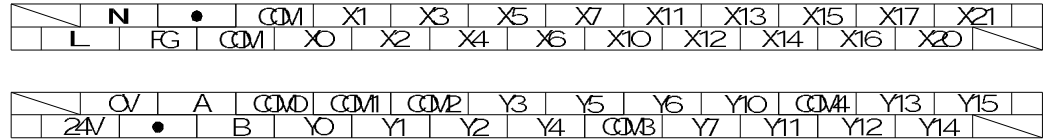

● Graph D

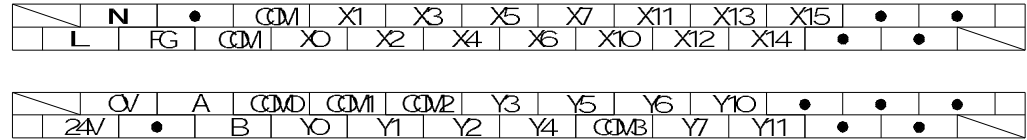

● Graph E

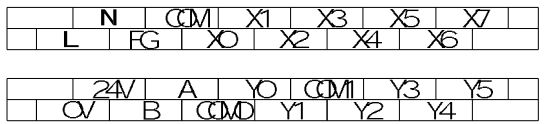

● Graph F

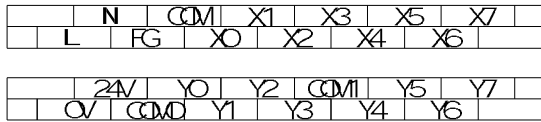

● Graph G

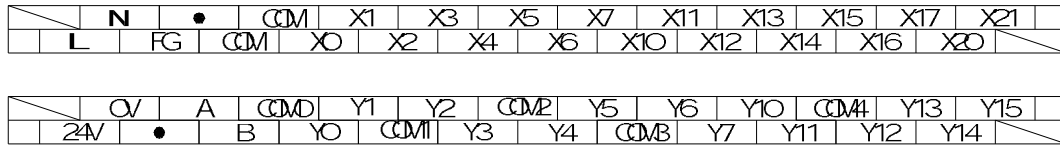

● Graph H

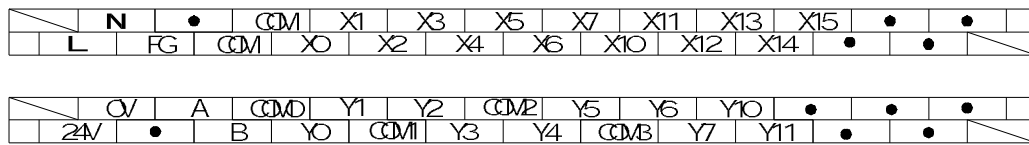

● Graph I

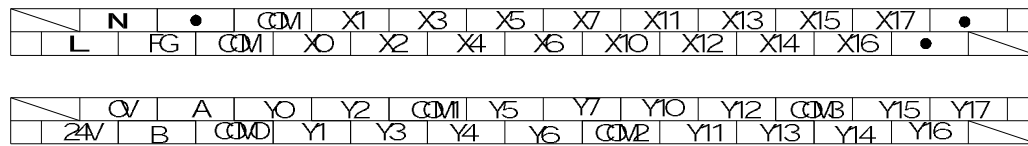

● Graph J

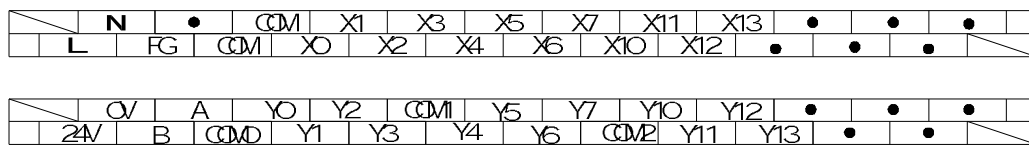

● Graph K



The Graph to the model:

Graph	Suitable Model	Comment
A	XC2-60、XC3- 60、XC5- 60	36 input/24 output

B	XC2-48、XC3- 48、XC5- 48	28 input/20 output
C	XC2-32、XC3- 32	18 input/14 output
D	XC2-24、XC3- 24	14 input/10 output
E	XC2-14、XC3- 14	8 input/6 output
F	XC1- 16、XC2-16	8 input/8 output
G	XC5- 32、XCM-32	18 input/14 output
H	XC5- 24、XCM-24	14 input/10 output
I	XC1- 32	16 input/16 output
J	XC1- 24	12 input/12 output
K	XC1-10	5 input/5 output

2-4. Communication Ports

COM1

Pins of COM1:

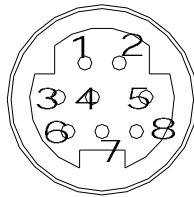

- 2: PRG
- 4: RxD
- 5: TxD
- 6: VCC
- 8: GND

Mini Din 8 female

COM2

Pins of COM2*1:

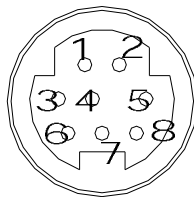

- 4: RxD
- 5: TxD
- 8: GND

Mini Din 8 female

Program Cable



※1: in the graph we show only RS232 of COM2, we extend RS485 (A, B) to the terminals), so we here don't list them out.
