

# Autonics TEMPERATURE CONTROLLER TAS/TAM/TAL SERIES

## MANUAL



Thank you very much for selecting Autonics products.  
For your safety, please read the following before using.

### Caution for your safety

- Please keep these instructions and review them before using this unit.
- Please observe the cautions that follow;
  - Warning** Serious injury may result if instructions are not followed.
  - Caution** Product may be damaged, or injury may result if instructions are not followed.
- The following is an explanation of the symbols used in the operation manual.
  - Caution:** Injury or danger may occur under special conditions.

### Warning

- In case of using this unit with machinery(Ex: nuclear power control, medical equipment, ship, vehicle, train, airplane, combustion apparatus, safety device, crime/disaster prevention equipment, etc) which may cause damages to human life or property, it is required to install fail-safe device. It may cause a fire, human injury or damage to property.
- It must be mounted on Panel. It may give an electric shock.
- Do not connect, inspect and repair terminals when it is power on. It may give an electric shock.
- Please check the number of terminal when connecting power or input. It may cause a fire.
- Do not disassemble or modify this unit, please contact us when it is required. It may cause a fire and give an electric shock.

### Caution

- This unit shall not be used outdoors. It might shorten the life cycle of the product or give an electric shock.
- When wire connection, AWG 20(0.50mm<sup>2</sup>) should be used and screw bolt on terminal block with 0.74 to 0.90N·m strength. It may result in malfunction or fire due to contact failure.
- For crimped terminal, select following shaped terminal.

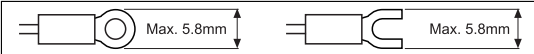

- Please observe specification rating. It might shorten the life cycle of the product and cause a fire.
- Do not use the load beyond rated switching capacity of Relay contact. It may cause insulation failure, contact melt, contact failure, relay broken, fire etc.
- In cleaning the unit, do not use water or an oil-based detergent. It might cause an electric shock or fire that will result in damage to the product.
- Do not use this unit at place where there are flammable or explosive gas, humidity, direct ray of the sun, radiant heat, vibration, impact etc. It may cause a fire or explosion.
- Do not inflow dust or wire drops into inside of this unit. It may cause a fire or mechanical trouble.
- Please wire properly after checking the polarity of terminals when connect thermocouples. It may cause a fire or explosion.
- In order to install the units with reinforced insulation, use the power supply unit which basic insulation level is ensured.

### Ordering information

TA	S	B	4	R	P	4	C
Unit							C Celsius(°C)
Temperature range for each sensor							F Fahrenheit(°F)
Sensor input type							Celsius(°C) Fahrenheit(°F) Temperature sensor
Control output							0 -50 to 100 -58 to 212 Pt - -
Power supply							1 0 to 100 32 to 212 Pt - K
Control method							2 0 to 200 32 to 392 Pt J K
Size							3 0 to 300 32 to 572 - J -
Item							4 0 to 400 32 to 752 Pt J K
							6 0 to 600 32 to 1,112 - - K
							8 0 to 800 32 to 1,472 - - K
							C 0 to 1,200 32 to 2,192 - - K
							P DPt100Ω
							J J(IC)
							K K(CA)
							R Relay output
							S SSR drive output
							4 100-240VAC 50/60Hz
							B ON/OFF control & PID control combined
							S DIN W48 x H48mm(8 pin plug type)*1
							M DIN W72 x H72mm
							L DIN W72 x H72mm
							TA Analog setting type temperature controller

\*1: Socket(PG-08, PS-08) is sold separately.

The above specifications are subject to change and some models may be discontinued without notice.

### Specification

Series	TAS	TAM	TAL
Power supply	100-240VAC 50/60Hz		
Allowable voltage range	90 to 110% of rated voltage		
Power consumption	Max. 4VA		
Size	DIN W48 x H48mm	DIN W72 x H72mm	DIN W96 x H96mm
Display method	Deviation LED(red, green), Output LED(red)		
Setting type	Dial setting		
Setting accuracy	F.S. ±2% (room temperature 23°C ±5°C)*1		
Input type	DPT 100Ω(allowable line resistance max. 5Ω per a wire)		
Thermocouples	K(CA), J(IC)		
Control	ON/OFF Control Hysteresis: 2°C Fixed		
PID Control	Control period: Relay output 20 sec./SSR drive output 2 sec.		
Relay	250VAC 3A 1c		
SSR	Max. 12VDC±2V 20mA		
Functions	PV deviation indication, Error indication		
Dielectric strength	2,000VAC 50/60Hz for 1minute(between input terminal and power terminal)		
Vibration	0.75mm amplitude at frequency of 5 to 55Hz in each of X, Y, Z directions for 2hours		
Relay life	Mechanical Min. 10,000,000 operation(18,000 times/hr)		
Electrical	Min. 100,000 operation(900 times/hr)		
Insulation resistance	Min. 100MΩ(at 500VDC megger)		
Noise strength	Square shaped noise by noise simulator(pulse width 1μs) ±2kV R-phase and S-phase		
Memory retention	Approx. 10 years (when using non-volatile semiconductor memory type)		
Environ-ment	Ambient temperature -10 to 50°C, Storage: -20 to 60°C		
Ambient humidity	35 to 85%RH, Storage: 35 to 85%RH		
Insulation type	Double insulation or reinforced insulation (mark: □, dielectric strength between the measuring input part and the power part: 2kV)		
Approval	CE, UL, US		
Weight*2	Approx. 112g(approx. 74g)	Approx. 176g(approx. 114g)	Approx. 237g(approx. 152g)

\*1: <Except normal temperature range> Below 100°C model is F.S. ±4%, Over 100°C model is F.S. ±3%  
\*2: The weight is with packaging and the weight in parentheses is only unit weight.  
\*Environment resistance is rated at no freezing or condensation.

### Front panel identification

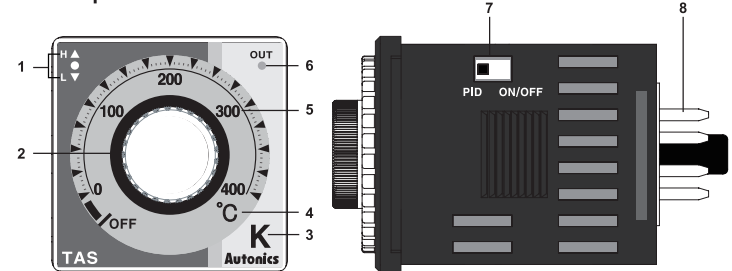

### 1. Deviation indicator

It shows deviation of present temperature(PV) based on set temperature(SV) by LED. Input deviation indicator[Deviation indicator: ●(green), ▲/▼(red)]

PV deviation temperature	Deviation indicator
Input sensor OPEN	▲ + ● + ▼ indicators flash(every 0.5 sec.)
Exceed max. input value	▲ + ● + ▼ indicator flashes(every 0.5 sec.)
More than 10°C	▲ + ● indicator turns ON
More than 2°C to less than or equal to 10°C	▲ + ● indicators turn ON
Less than or equal to ±2°C	● indicator turns ON
More than -2°C to less than or equal to -10°C	● + ▼ indicators turn ON
More than -10°C	▼ indicator turns ON
Less than min. input value	▼ indicator flashes(every 0.5 sec.)

\*This is the same as Fahrenheit(°F).

When power is on, all indicators light for 2 sec., then all indicators turn off and control operation starts.

### 2. Set temperature(SV) dial

Dial to change set temperature (SV). When changing set temperature, it is applied after 2 sec. for the stable input.

### 3. Input sensor

Indicates sensor type of present value. Input sensor type or input range each product is shown in the below table.

Input Sensor	Range No.	Input range(°C)	Input range(°F)
Thermocouple	K(CA)	1	0 to 100 32 to 212
		2	0 to 200 32 to 392
		4	0 to 400 32 to 752
		6	0 to 600 32 to 1,112
	J(IC)	C	0 to 1,200 32 to 2,192
		2	0 to 200 32 to 392
		3	0 to 300 32 to 572
		4	0 to 400 32 to 752
RTD	DPt100Ω	0	-50 to 100 -58 to 212
		1	0 to 100 32 to 212
		2	0 to 200 32 to 392
		4	0 to 400 32 to 752

\*Set temperature within input range each sensor.

### 4. Temperature unit

Indicates temperature unit(°C, °F) of set temperature(SV) and present value(PV).

### 5. Temperature range

Indicates temperature range of set temperature(SV)

### 6. Control output indicator

Turns ON when control output (Relay Output/SSR Output)

### 7. Control mode selection switch

Select PID control or ON/OFF control using switch.

### 8. Terminal block

Terminals for external connections. For more information, refer to 'Connections'.

### Dimensions

#### 1. TAS Series

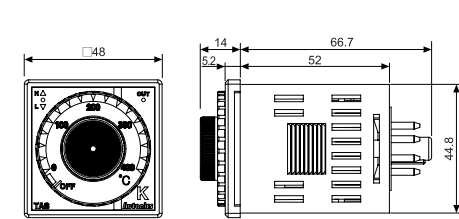

#### 2. TAM Series

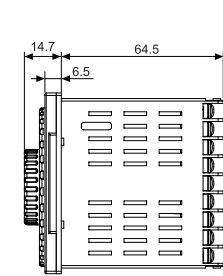
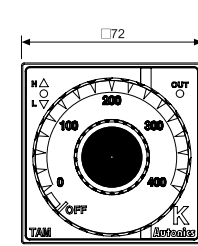

#### Bracket

##### TAS Series

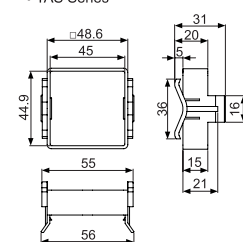

##### TAM, TAL Series

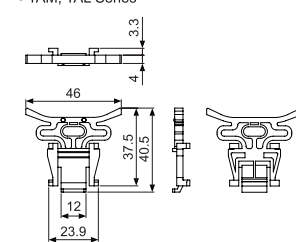

#### Terminal cover(sold separately)

##### RMA-COVER(72×72mm)

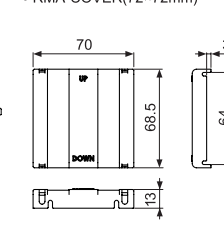

##### RLA-COVER(96×96mm)

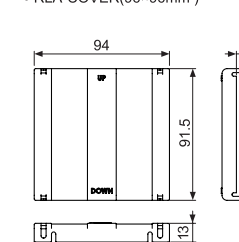

#### Panel cut-out

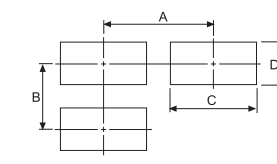

Series	Size	A	B	C	D
TAS	Min. 65	Min. 65	45 <sup>+0.8</sup> <sub>0</sub>	45 <sup>+0.6</sup> <sub>0</sub>	
TAM	Min. 90	Min. 90	68 <sup>+0.7</sup> <sub>0</sub>	68 <sup>+0.7</sup> <sub>0</sub>	
TAL	Min. 115	Min. 115	92 <sup>+0.8</sup> <sub>0</sub>	92 <sup>+0.8</sup> <sub>0</sub>	

### Functions

#### 1. SSR drive output

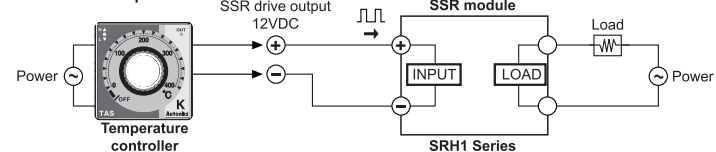

#### 2. ON/OFF control

ON/OFF control function is for controlling temperature by comparing present temperature(PV) to set temperature(SV). ON/OFF control is fixed on reverse operation(Heating). Output turns on to supply power temperature(SV) and the output turns off to turn off heater when present temperature(PV) is higher than set temperature(SV).  
\*Hysteresis is fixed at 2°C during ON/OFF control.

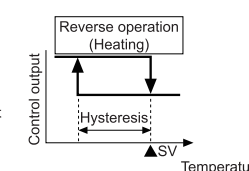

#### 3. PID Control

PID constants are suggested and implemented based on self tuning from supply power until reaching set temperature(SV), then self tuning is over after reaching set temperature(SV). When power supply, in case that set temperature(SV) dial points at OFF or self tuning can not be started because present temperature(PV) is higher than set temperature(SV) or hunting occurs during self tuning, output control is switched to proportion band(P) because that is considered to error. At that time, proportion band is fixed at 10°C.  
\*Control cycle of PID control and proportion control is 20 sec. in relay output model and 2 sec. in SSR drive output model.

#### 4. STOP

Control output could stop without power off by setting the front setting volume to below min. setting range. If control output stops by STOP function, green indicator in deviation indicator(●) will flash every 1 sec.

#### 5. Error

Error mark will flash(every 1 sec.) in PV indicator when error occurs during the control operation. It will operate normally, if input sensor is connected or temperature is returned to normal range.

No	Display	Description
1	▲ + ● + ▼ indicators flash	If input sensor is broken or sensor is not connected.
2	▲ indicator flashes	If measured sensor input is higher than temperature range.
3	▼ indicator flashes	If measured sensor input is lower than temperature range.

### Connections

\*RTD(Platinum resistance thermometer): DPt100Ω(3-wire) \*T.C.(Thermocouple): K(CA), J(IC)  
(\*Socket(PG-08, PS-08) is sold separately.)

#### 1. TAS Series

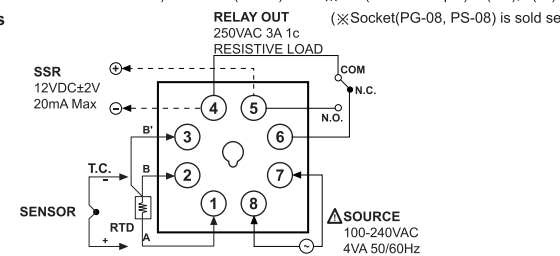

#### 2. TAM Series

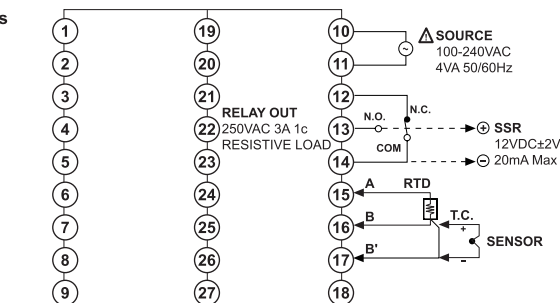

#### 3. TAL Series

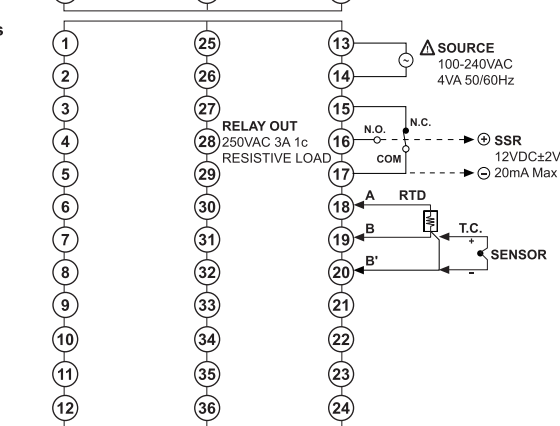

### Installation

#### 1. TAS Series

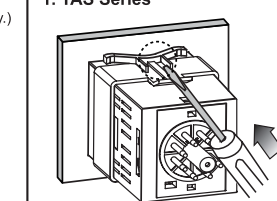

\*Mount the product on the panel and securely push the bracket in using a tool, as shown in the diagram.

#### 2. TAM, TAL Series

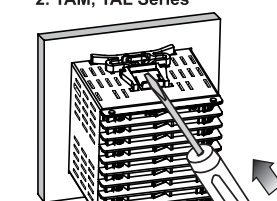

### Caution for using

- Please use separated line from high voltage line or power line in order to avoid inductive noise.
- Install power switch or circuit-breaker in order to on/off the power.
- The switch or circuit-breaker should be installed nearby users for safety.
- Do not use this product as Volt-meter or Ampere-meter, this is a temperature controller.
- In case of using RTD sensor, 3-wire type must be used. If you need to extend the line, 3 wires must be used with the same thickness as the line. It might cause the deviation of temperature if the resistance of line is different.
- In case of making power line and input signal line closely, line filter for noise protection should be installed at power line and input signal line should be shielded.
- Keep away from the high frequency instruments. (High frequency welding machine & sewing machine, large capacity SCR controller)
- Installation environment
  - It shall be used indoor.
  - Altitude Max. 2,000m
  - Pollution Degree 2
  - Installation Category II

\*It may cause malfunction if above instructions are not followed.

### Major products

- Photoelectric sensors
- Fiber optic sensors
- Door sensors
- Door side sensors
- Area sensors
- Proximity sensors
- Pressure sensors
- Rotary encoders
- Connector/sockets
- Switching mode power supplies
- Control switches/Lamps/Buzzers
- I/O Terminal Blocks & Cables
- Stepper motors/drivers/motion controllers
- Graphic/Logic panels
- Field network devices
- Laser marking system(Fiber, CO<sub>2</sub>, Nd:YAG)
- Laser welding/soldering system
- Temperature controllers
- Temperature/Humidity transducers
- SSR/Power controllers
- Counters
- Timers
- Panel meters
- Tachometer/Pulse(Rate) meters
- Display units
- Sensor controllers

**Autonics Corporation**  
http://www.autonics.com

Satisfiable Partner For Factory Automation

HEAD QUARTERS:  
18, Bansong-ro 513beon-gil, Haeundae-gu, Busan, Korea

OVERSEAS SALES:  
#402-404, Bucheon Techno Park, 655, Pyeongcheon-ro, Wonmi-gu, Bucheon, Gyeonggi-do, Korea  
TEL: 82-32-610-2730 / FAX: 82-32-329-0728  
E-mail: sales@autonics.com