

# Autonics

## PULSE METER MP5S SERIES

### M A N U A L



Thank you very much for selecting Autonics products.  
For your safety, please read the following before using.

#### Caution for your safety

- ※Please keep these instructions and review them before using this unit.
- ※Please observe the cautions that follow:
- Warning** Serious injury may result if instructions are not followed.
- Caution** Product may be damaged, or injury may result if instructions are not followed.
- ※The following is an explanation of the symbols used in the operation manual.
- ⚠caution: Injury or danger may occur under special conditions.

#### Warning

- In case of using this unit with machineries(Nuclear power control, medical equipment, vehicle, train, airplane, combustion apparatus, entertainment or safety device etc), it requires installing fail-safe device, or contact us for information on type required.**  
It may result in serious damage, fire or human injury.
- It must be mounted on panel.**  
It may give an electric shock.
- Do not repair or check up when power on.**  
It may give an electric shock.
- Do not disassemble and modify this unit, when it requires. If needs, please contact us.**  
It may give an electric shock and cause a fire.
- Please check the number of terminal when connect power line or measuring input.**  
It may cause a fire.

#### Caution

- This unit shall not be used outdoors.**  
It might shorten the life cycle of the product or give an electric shock.
- When wire connection for power input and measuring input, the tightening strength for screw bolt on terminal block should be over than 0.74N · m ~ 0.90N · m.**  
It may result in malfunction or fire due to contact failure.
- Please observe specification rating.**  
It might shorten the life cycle of the product and cause a fire.
- Do not use the load beyond rated switching capacity of Relay contact.**  
It may cause insulation failure, contact melt, contact failure, relay broken, fire etc.
- In cleaning the unit, do not use water or an oil-based detergent.**  
It might cause an electric shock or fire that will result in damage to this product.
- Do not use this unit at place where there are flammable or explosive gas, humidity, direct ray the sun, radiant heat, vibration, impact etc.**  
It may cause a fire or explosion.
- Do not inflow dust or wire dregs into inside of this unit.**  
It may cause a fire or mechanical trouble.
- Please connect properly after checking the polarity measuring terminals.**  
It may cause a fire or explosion.

※The above specification are changeable without notice anytime.

#### Ordering information

|                |    |  |   |   |   |   |
|----------------|----|--|---|---|---|---|
|                | MP | 5                                      | S | - | 4 | N |
|                | ①  | ②                                      | ③ | ④ | ⑤ |   |
| ① Series       | MP | Pulse meter                            |   |   |   |   |
| ② Digit        | 5  | 5Digit(99999)                          |   |   |   |   |
| ③ Size         | S  | DIN Size W48 × H48mm                   |   |   |   |   |
| ④ Power supply | 4  | 100-240VAC 50/60Hz                     |   |   |   |   |
| ⑤ Output       |    | Main output(Comparative value output)  |   |   |   |   |
|                | N  | Indication type only                   |   |   |   |   |
|                | 2  | Relay two-stage(High/Low-limit) output |   |   |   |   |

#### Specifications

| Model                        | MP5S-4N  | MP5S-42  |
|------------------------------|--|--|
|                              | Indication   | High/Low-limit setting   |
| Power supply                 | 100-240VAC 50/60Hz   |  |
| Allowable operation voltage  | 90 to 110% of rated voltage  |  |
| Power consumption            | Approx. 7.5VA(240VAC)  | Approx. 8VA(240VAC)  |
| Power for external sensor    | 12VDC ±10%, 80mA   |  |
| Measuring accuracy (23 ±5°C) | <ul style="list-style-type: none"> <li>Mode F1, F4, F7, F8, F9, F10 : F.S. ±0.05% rdg ±1Digit</li> <li>Mode F2, F3, F5, F6 : F.S. ±0.01% rdg ±1Digit</li> </ul>  |  |
| Measuring range              | <ul style="list-style-type: none"> <li>Mode F1, F4, F7, F8, F9, F10 : 0.0005Hz to 50kHz</li> <li>Mode F3 : 0.02s to 3,200s</li> <li>Mode F2, F5, F6 : 0.01s to 3,200s</li> <li>Mode F11, F12, F13 : 0 ~ 4 × 10<sup>9</sup> Count</li> </ul>                  |  |
| Input frequency              | <ul style="list-style-type: none"> <li>Solid state input : Max. 50kHz(Pulse width:Min. 10μs)</li> <li>Contact input : Max. 45Hz(Pulse width:Min. 11ms)</li> </ul>  |  |
| Input level                  | [Voltage input] High : 4.5-24VDC, Low : 0-1VDC, Input impedance : 4.5kΩ<br>[No-voltage input] Short-circuit impedance : Max. 300Ω, Residual voltage : Max. 1V, Open-circuit impedance : Min. 100kΩ   |  |
| Max. indication              | 5Digit(0.0001 to 99999)  |  |
| Display method               | 7 Segment LED(Zero blanking), Display size : W4×H8mm   |  |
| Display accuracy             | 0.05 / 0.5 / 1 / 2 / 4 / 8sec.(The same as update output cycle)  |  |
| Operation mode               | Number of revolution/Speed/Frequency(F1), Passing speed(F2), Cycle(F3), Passing time(F4), Time width(F5), Time difference(F6), Absolute rate(F7), Error ratio(F8), Density(F9), Error(F10), Length measurement(F11), Interval(F12), Integration(F13)         |  |
| Prescale function            | Direct input method(0.0001 × 10 <sup>-9</sup> to 9.9999 × 10 <sup>9</sup> )  |  |
| Hysteresis                   | 0 to 9999  |  |
| Other functions              | <ul style="list-style-type: none"> <li>Lock setting function</li> <li>Auto-Zero time setting function</li> <li>Time unit selection function</li> <li>Display value monitoring function</li> <li>Memory retention function (Mode F13 applied only)</li> </ul> | <ul style="list-style-type: none"> <li>Lock setting function</li> <li>Monitoring function</li> <li>Auto-Zero time setting function</li> <li>Time unit selection function</li> <li>Display value monitoring function</li> <li>Memory retention function (Mode F13 applied only)</li> <li>Comparative output function (H, L)</li> <li>Output mode selection function(S, H, L, B, I, F)</li> <li>Deviation memory function (F output mode)</li> </ul> |
| Main output                  | Relay output   | 250VAC 3A resistive load 1a × 2  |
| Memory                       | Non-volatile memory(Input times : 100,000 times)   |  |
| Insulation resistance        | Min. 100MΩ(Standard 500VDC) between terminal and case  |  |
| Dielectric strength          | 2000VAC 60Hz 1minute(Between terminals of AC power and case, Between terminals of AC power and measuring terminals)  |  |
| Impulse noise strength       | ±2000V the square wave noise(pulse width:1μs) by the noise simulator R/S phase, repetition frequency 60Hz  |  |
| Vibration                    | Mechanical   | 0.75mm amplitude at frequency of 10 to 55Hz in each of X, Y, Z directions for 2 hours  |
|                              | Malfunction  | 0.5mm amplitude at frequency of 10 to 55Hz in each of X, Y, Z directions for 10 minutes  |
| Shock                        | Mechanical   | 300m/s <sup>2</sup> (Approx. 30G) 3 times at X, Y, Z direction   |
|                              | Malfunction  | 100m/s <sup>2</sup> (Approx. 10G) 3 times at X, Y, Z direction   |
| Relay life cycle             | Mechanical   | Min. 10,000,000 operations   |
|                              | Electrical   | Min. 100,000 times at 250VAC 3A(resistive load)  |
| Ambient temperature          | -10 to 50°C(at non-freezing status)□   |  |
| Storage temperature          | -20 to 60°C(at non-freezing status)□   |  |
| Ambient humidity             | 35 to 85%RH  |  |
| Weight                       | Approx. 130g   | Approx. 140g   |

#### Dimensions

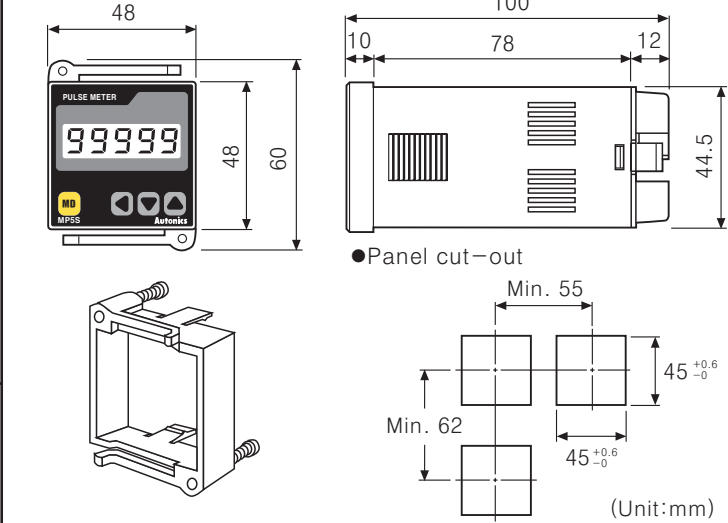

#### Connections

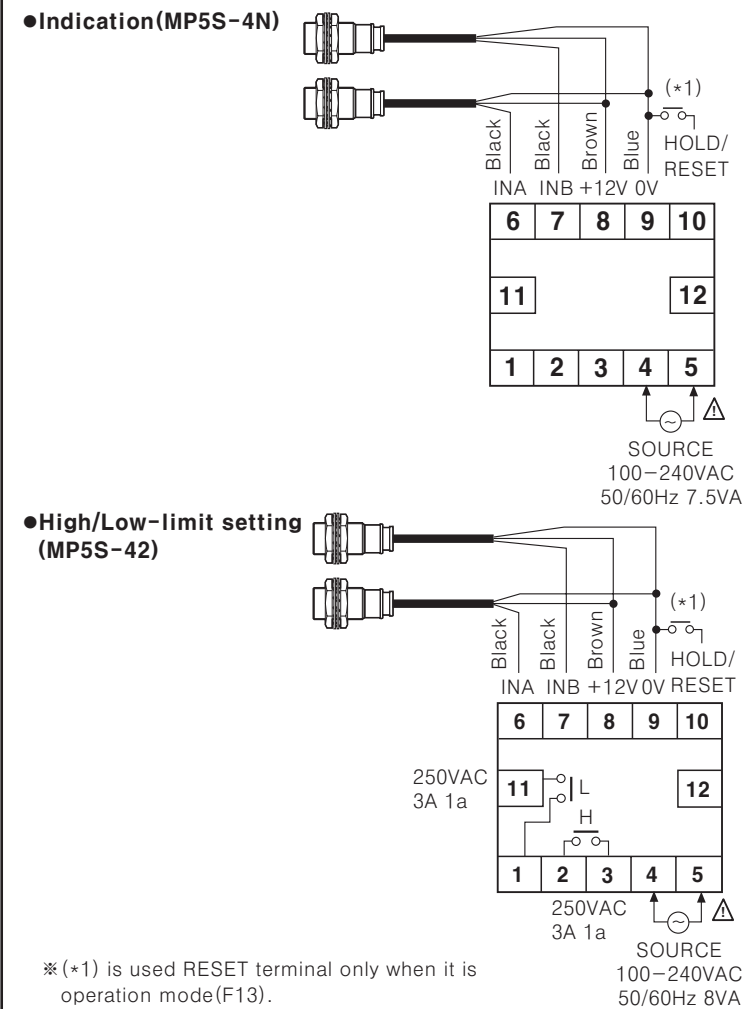

#### Input · Output

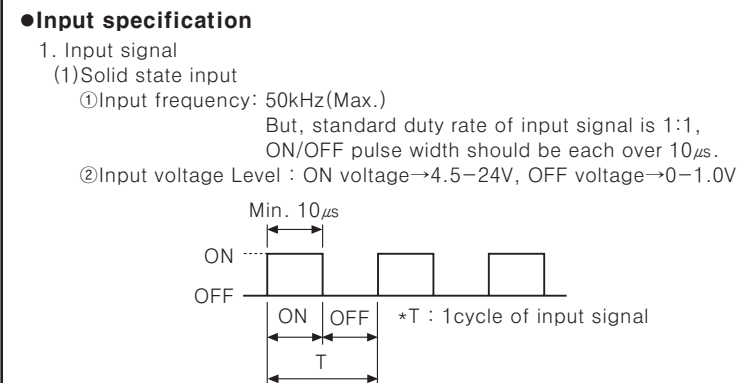

- Relay contact input
  - ①Input frequency : 45Hz(Max.)  
But, ON/OFF pulse width should be each over 11ms.
  - ②Relay contact specification : Please use a contact that can switch reliably at 12VDC, 2mA min. of load current.

- Input type
  - MP5S has **NPN input and PNP input** and it is able to select it in parameter 1 group.

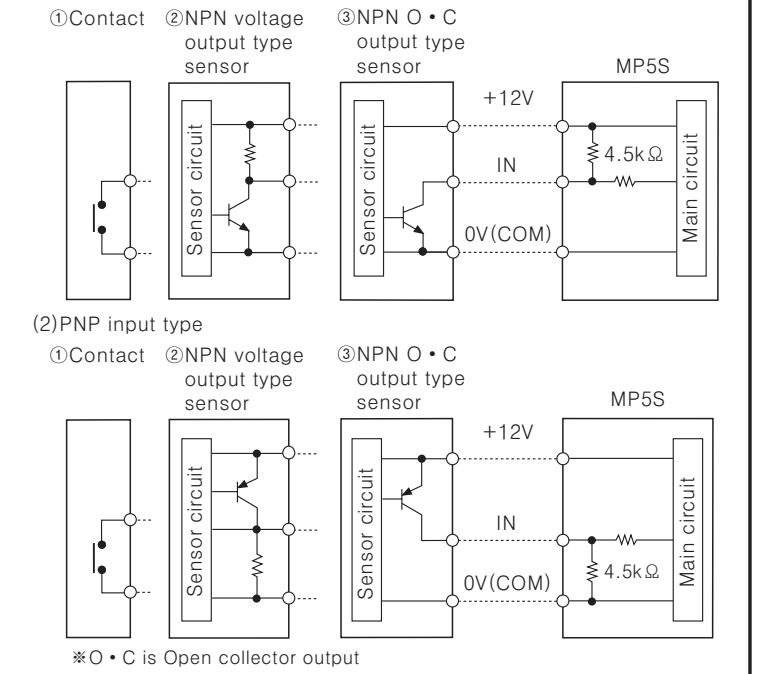

#### Operation mode

- Select operation mode from **mode** of parameter 1 group.
  - There are 13 kinds of operation mode.
- ◎**Mode F1(Frequency/Number of revolution/Speed)**  
This mode is to display calculated frequency or number of revolution, speed by measuring frequency of Input A.
- Frequency(Hz) =  $f \times \alpha$  ( $\alpha = 1[\text{sec}]$ )
  - Number of revolution(rpm) =  $f \times \alpha$  ( $\alpha = 60[\text{sec}]$ )
  - Speed(m/min) =  $f \times \alpha$  ( $\alpha = 60L[\text{sec}]$ )
- ※f : Number of input pulses per second  
L = The length of conveyor moved for 1 pulse cycle[m]
- Display value and display unit
- | Display value        | Display unit | $\alpha$ (Prescale value) |
|----------------------|--------------|---------------------------|
| Frequency            | Hz           | 1                         |
|                      | kHz          | 0.001                     |
| Number of revolution | RPS          | 1                         |
|                      | rpm          | 60                        |
| Speed                | mm / sec     | 1,000L                    |
|                      | cm / sec     | 100L                      |
|                      | m / sec      | L                         |
|                      | m / min      | 60L                       |
|                      | km / hour    | 3.6L                      |
- ※Display unit of factory default : rpm

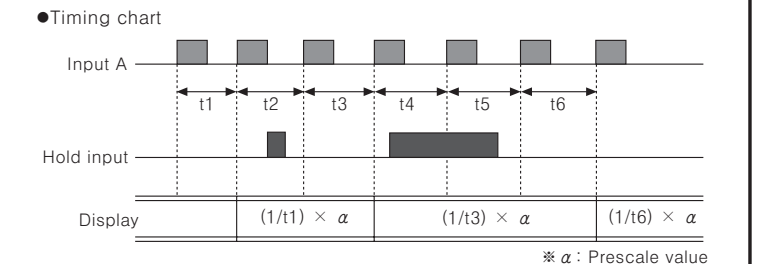

- ◎**Mode F2(Passing speed)**  
It displays the passing speed between ON of input A and ON of input B.  
Passing speed(V) =  $f \times \alpha$  ( $\alpha = L[\text{m}]$ )  
※f : This is reciprocal number of the time between ON of input A and ON of input B.  
L : The distance between input A and input B[m]

●Display value and display unit

| Display value | Display unit | $\alpha$ (Prescale value) |
|---------------|--------------|---------------------------|
| Passing speed | mm / sec     | 1,000L                    |
|               | cm / sec     | 100L                      |
|               | m / sec      | L                         |
|               | m / min      | 60L                       |
|               | km / hour    | 3.6L                      |

\*Display unit of factory default : m/sec

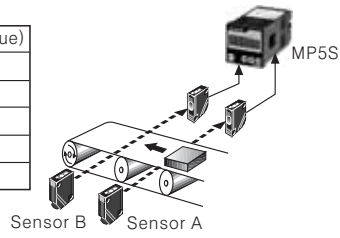

●Timing chart

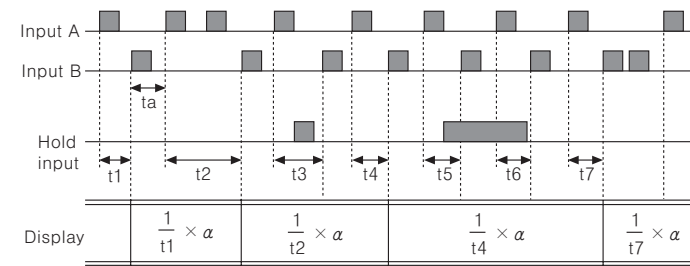

\*  $\alpha$  : Prescale value  
 ta : It needs min. 20ms for return time

●Mode F3(Cycle)

It displays the time from when input A is ON to the next ON of input A .

Cycle(T) = t

\*t : Measurement time[sec]

●Display value and display unit

| Display value | Display unit |
|---------------|--------------|
| Cycle         | SEC          |
|               | MIN          |
|               | 999.99sec.   |
|               | 9999.9min.   |
|               | 9999.9min.   |
|               | 99999sec.    |
|               | 99999min.    |

\*Set the display unit at the **Unit**(Time unit) of parameter 2.

\*Display unit of factory default : 999.99sec.

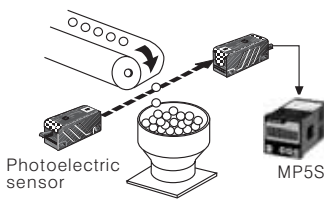

●Timing chart

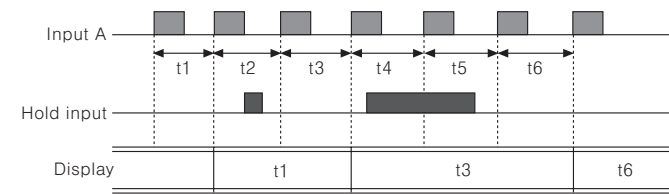

\*t:Measurement time[sec], L: Certain distance[m]

●Mode F4(Passing time)

It displays the passing time of certain distance as measuring the time between ON and the next ON of Input A.

$$\text{Passing time[sec]} = t \times \alpha \left( \alpha = \frac{L[m]}{\text{Moving distance within 1 pulse cycle[m]}} \right)$$

\*t:Measurement time[sec], L: Certain distance[m]

●Display value and display unit

| Display value | Display unit      |
|---------------|-------------------|
| Passing time  | SEC               |
|               | MIN               |
|               | 999.99sec         |
|               | 999.99min         |
|               | 9999.9sec         |
|               | 9999.9min         |
|               | 99min 59.9sec     |
|               | 99hour 59.9min    |
|               | 9hour 59min 59sec |
|               | 999hour 59min     |
|               | 99999sec          |
|               | 99999min          |

\*Display unit of factory default : 999.99sec.

\*Set the display unit at the **Unit**(Time unit) of parameter 2.

●Timing chart

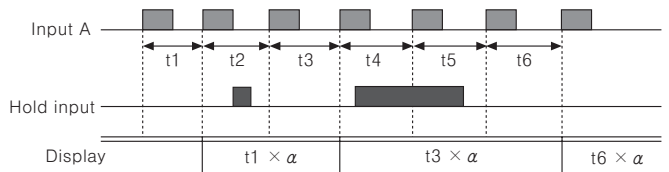

\*  $\alpha$  : Prescale value

●Mode F5(Time width)

It displays the ON time of input A.

Time width[T] = t

\*t : ON measurement time of input A[sec]

●Display value and display unit

| Display value | Display unit      |
|---------------|-------------------|
| Passing time  | SEC               |
|               | MIN               |
|               | 999.99sec         |
|               | 999.99min         |
|               | 9999.9sec         |
|               | 9999.9min         |
|               | 99min 59.9sec     |
|               | 99hour 59.9min    |
|               | 9hour 59min 59sec |
|               | 999hour 59min     |
|               | 99999sec          |
|               | 99999min          |

\*Display unit of factory default:999.99sec.

\*Set the display unit at the **Unit**(Time unit) of parameter 2.

\*Display unit of factory specification : 999.99sec.

●Timing chart

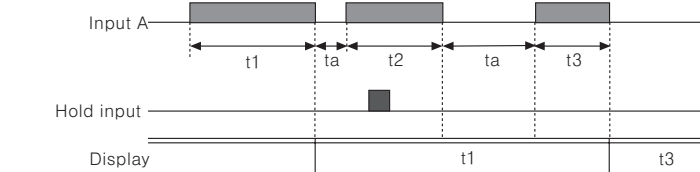

\*ta : It needs min. 20ms for return time.

●Mode F6(Time interval)

It displays the time from input A is ON to input B is ON.

Time difference(T) = t(ta to tb)

\*t(ta to tb) : The measurement time from input A is ON to input B is ON[sec].

●Display value and display unit

| Display value | Display unit      |
|---------------|-------------------|
| Passing time  | SEC               |
|               | MIN               |
|               | 999.99sec         |
|               | 999.99min         |
|               | 9999.9sec         |
|               | 9999.9min         |
|               | 99min 59.9sec     |
|               | 99hour 59.9min    |
|               | 9hour 59min 59sec |
|               | 999hour 59min     |
|               | 99999sec          |
|               | 99999min          |

\*Display unit of factory default : 999.99sec.

\*Display unit can be set at **Unit**(Time unit) of parameter 2.

●Timing chart

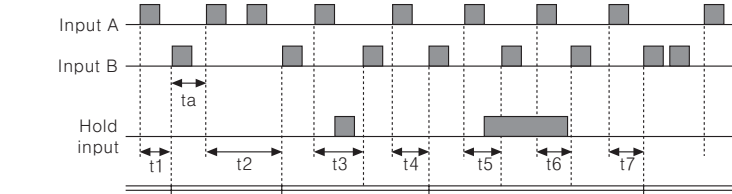

\*ta : It needs min.20ms for return time.

●Mode F7(Absolute rate)

It displays how many percentage(%) faster or late, speed, volume etc.

of Input B against input A.

Absolute rate = (Input B / Input A) × 100%

$$\text{Absolute rate} = \frac{\text{Frequency of input B[Hz]} \times B\alpha}{\text{Frequency of input A[Hz]} \times A\alpha} \times 100\%$$

●Display value and display unit

| Display value | Display unit |
|---------------|--------------|
| Absolute rate | %            |

\*A $\alpha$  : Prescale value of input A  
 B $\alpha$  : Prescale value of input B

●Timing chart

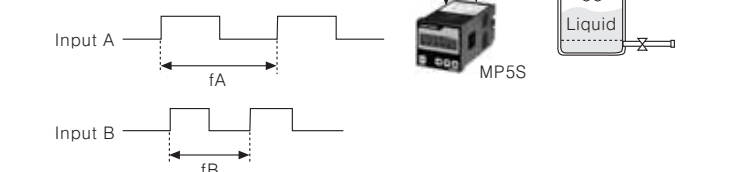

$$\text{Display} = \frac{\text{Frequency of input B[Hz]} \times B\alpha}{\text{Frequency of input A[Hz]} \times A\alpha} \times 100\%$$

\*Hold : Hold signal is ON, the display value will be held until Hold signal is OFF.

●Mode F8(Error ratio)

It displays how many percentage(%) faster or late of Input B against Input A.

$$\text{Absolute rate} = \frac{\text{Input B} - \text{Input A}}{\text{Input A}} \times 100\%$$

$$\text{Error rate} = \frac{(\text{Frequency of input B[Hz]} \times B\alpha) - (\text{Frequency of input A[Hz]} \times A\alpha)}{\text{Frequency of input A[Hz]} \times A\alpha} \times 100\%$$

●Display value and display unit

| Display value | Display unit |
|---------------|--------------|
| Error rate    | %            |

\*A $\alpha$  : Prescale value of input A  
 B $\alpha$  : Prescale value of input B

●Timing chart

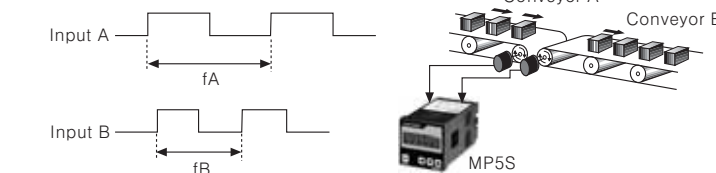

$$\text{Display} = \frac{(\text{Frequency of input B[Hz]} \times B\alpha) - (\text{Frequency of input A[Hz]} \times A\alpha)}{\text{Frequency of input A[Hz]} \times A\alpha} \times 100\%$$

\*Hold : Hold signal is ON, the display value will be held until hold signal is OFF.

●Mode F9(Density)

It displays the density rate of input B against total sum of input A and input B.

$$\text{Density} = \frac{\text{Input B}}{\text{Input A} + \text{Input B}} \times 100\%$$

$$\text{Density} = \frac{\text{Frequency of input B[Hz]} \times B\alpha}{(\text{Frequency of input A[Hz]} \times A\alpha) + (\text{Frequency of input B[Hz]} \times B\alpha)} \times 100\%$$

●Display value and display unit

| Display value | Display unit |
|---------------|--------------|
| Density       | %            |

\*A $\alpha$  : Prescale value of input A  
 B $\alpha$  : Prescale value of input B

●Timing chart

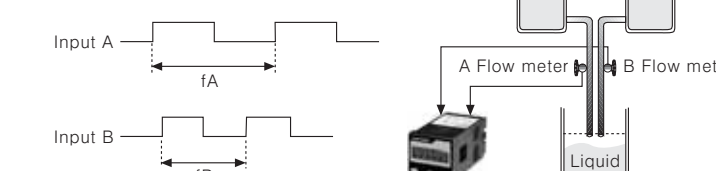

$$\text{Display} = \frac{\text{Frequency of input B[Hz]} \times B\alpha}{(\text{Frequency of input A[Hz]} \times A\alpha) + (\text{Frequency of input B[Hz]} \times B\alpha)} \times 100\%$$

\*Hold : Hold signal is ON, the display value will be held until hold signal is OFF.

●Mode F10(Error)

It displays the error between standard Input A and comparing Input B.

Error = Input B - Input A

Error = (Frequency of input B[Hz] × B $\alpha$ ) - (Frequency of input A[Hz] × A $\alpha$ )

●Display value and display unit

| Display value | Display unit          |
|---------------|-----------------------|
| Error         | END User setting unit |

\*A $\alpha$  : Prescale of input A  
 B $\alpha$  : Prescale of input B

●Timing chart

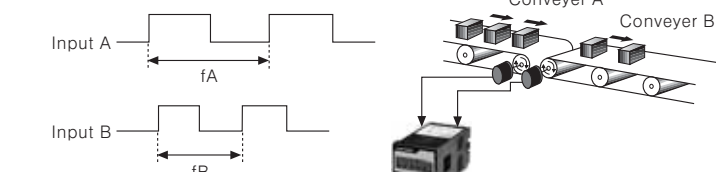

$$\text{Display} = (\text{Frequency of input B[Hz]} \times B\alpha) - (\text{Frequency of input A[Hz]} \times A\alpha)$$

\*Hold : Hold signal is ON, the display value will be held until hold signal is OFF.

●Mode F11(Length measurement)

It displays the number of Input A pulse while Input B is ON.

Length measurement = P ×  $\alpha$

(\*P : Number of input A pulse,  $\alpha$  : Prescale value)

●Display value and display unit

| Display value      | Display unit |
|--------------------|--------------|
| Length measurement | Quantity[EA] |
|                    | mm           |
|                    | cm           |
|                    | m            |

\*Factory default(Unit) : Quantity[EA]

●Timing chart

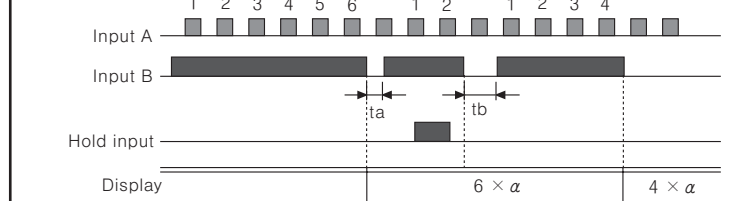

\*ta, tb : It needs min. 20ms for return time

●Mode F12(Interval)

It displays the number of Input A pulse from Input B is ON to the time Input B is ON next.

Interval = P ×  $\alpha$

(\*P : Number of input A pulse,  $\alpha$  : Prescale value)

●Display value and display unit

| Display value      | Display unit |
|--------------------|--------------|
| Length measurement | Quantity[EA] |
|                    | mm           |
|                    | cm           |
|                    | m            |

\*Factory default(Unit) : Quantity[EA]

●Timing chart

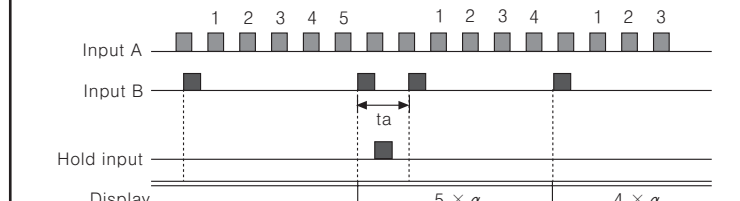

\*ta : It needs min. 20ms for return time

●Mode F13(Integration)

It displays the counting value against pulses of Input A.

Integration = P ×  $\alpha$

\*P : Pulse number of input A,  $\alpha$  : Prescale value

●Display value and display unit

| Display value | Display unit |
|---------------|--------------|
| Interval      | Quantity[EA] |

●Operation and Time chart

- It counts the number of input A pulse.
- As input B is an enable input signal it stops the counting and display value of input A when it is ON and then it counts input A continuously when it is OFF.
- If RESET input is ON, calculated counting value will be initialized.

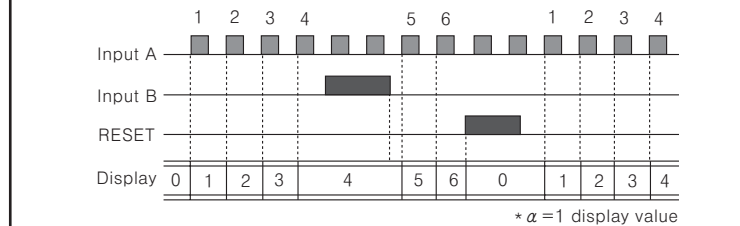

■ Output mode

- Select output mode in **out-t**(output type) of Parameter1 group.
- There are 2 stages output(H, L).
- There are 6 kinds of output mode such as S(Standard) output mode, H(High) output mode, L(Low) output mode, B(Block) output mode, I(One shot)output mode, F(Deviation)output mode.
- It operates individually not related to the order of the setting value (H,L).
- It is applied at MP5M-42 only.



○ S(Standard) output mode[StAr-d], B(Block) output mode[out-b]

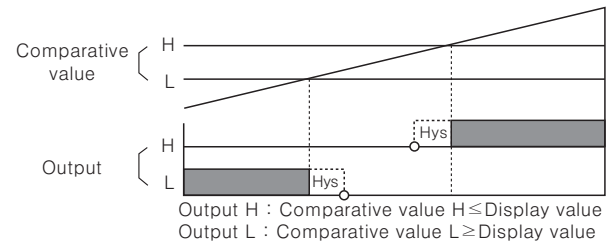

○ H(High) output mode[out-h]

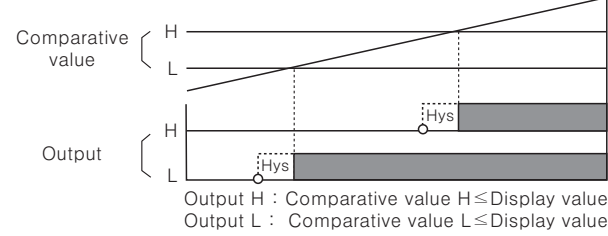

○ L(Low) output mode[out-l]

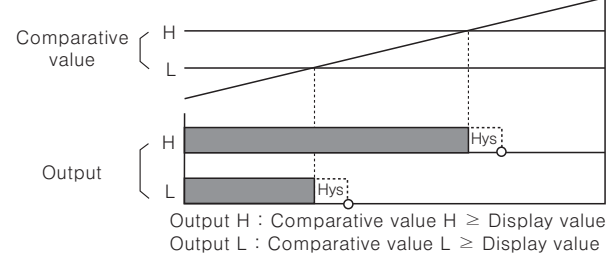

○ I(One Shot) output mode[out-f]

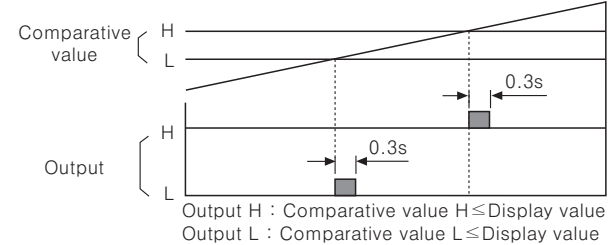

※ One Shot (■) output time has been fixed 0.3sec.  
※ There is no Hysteresis in I(One shot) comparative output mode.

○ F(Deflection) output mode[out-F]

This function is to memorize the setting value and provide outputs when it exceeds the deviation of H, L.

● The setting value memory : Memorize the current display value as the setting value by pressing (MD) + (▲) key in front.

● Display the setting value : Check the memorized the setting value by (▲) key. (Display the memorized setting value for pressing (▲) key continuously.)

● Deviation setting : Set H, L deviation by setting value. (The set deviation will be memorized until set the next deviation again when power off.)

● Deviation setting range : 0.0001 to 99999 (The setting range will be changed by decimal point setting parameter. If set decimal point as 0000.0, the setting range will be 0.1 to 9999.9.)

● Operation

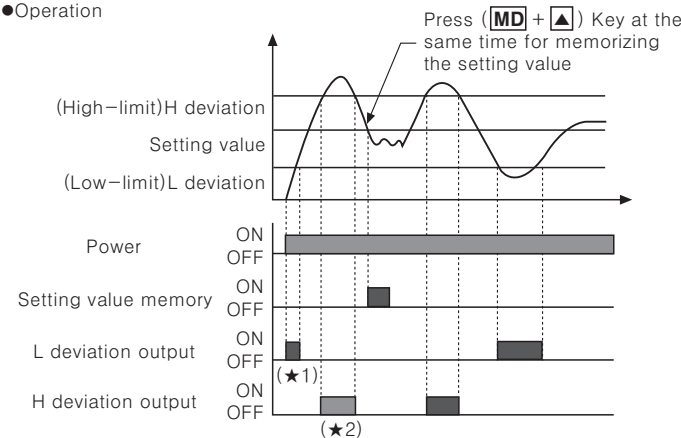

※ (★1) When select the comparative output limit function, output will not be come.

※ (★2) Output position may different from above graph as output coming under assuming the setting value memory is before the setting value memory point on above graph.

※ Even thought you set the deviation as "0(Zero)", it will actually work as setting "1".

## Operation chart by each Parameter group

● The display parameter are different by each operation mode, please see "Parameter".

● ○ : When select the operation mode, the parameter will be displayed.  
X : When select the operation mode, the parameter will not be displayed.

### Parameter 0 group

| Parameter 0 | Sub mode | F1 | F2 | F3 | F4 | F5 | F6 | F7 | F8 | F9 | F10 | F11 | F12 | F13 |
|-------------|----------|----|----|----|----|----|----|----|----|----|-----|-----|-----|-----|
| PSt. h      |          | ○  | ○  | ○  | ○  | ○  | ○  | ○  | ○  | ○  | ○   | ○   | ○   | ○   |
| PSt. L      |          | ○  | ○  | ○  | ○  | ○  | ○  | ○  | ○  | ○  | ○   | ○   | ○   | ○   |
| h.PEK       |          | ○  | ○  | ○  | ○  | ○  | ○  | ○  | ○  | ○  | ○   | ○   | ○   | X   |
| L.PEK       |          | ○  | ○  | ○  | ○  | ○  | ○  | ○  | ○  | ○  | ○   | ○   | ○   | X   |

### Parameter 1 group

| Parameter 1 | Sub mode | F1 | F2 | F3 | F4 | F5 | F6 | F7 | F8 | F9 | F10 | F11 | F12 | F13 |
|-------------|----------|----|----|----|----|----|----|----|----|----|-----|-----|-----|-----|
| mode        |          | ○  | ○  | ○  | ○  | ○  | ○  | ○  | ○  | ○  | ○   | ○   | ○   | ○   |
| In-A        |          | ○  | ○  | ○  | ○  | ○  | ○  | ○  | ○  | ○  | ○   | ○   | ○   | ○   |
| In-b        |          | X  | ○  | X  | X  | X  | ○  | ○  | ○  | ○  | ○   | ○   | ○   | ○   |
| out-t       |          | ○  | ○  | ○  | ○  | ○  | ○  | ○  | ○  | ○  | ○   | ○   | ○   | X   |
| hyS         |          | ○  | X  | X  | X  | X  | X  | ○  | ○  | ○  | ○   | X   | X   | X   |
| GuAr.d      | F.dEFy   | ○  | ○  | ○  | ○  | ○  | ○  | ○  | ○  | ○  | ○   | ○   | ○   | X   |
|             | StAr.t   | ○  | ○  | ○  | ○  | ○  | ○  | ○  | ○  | ○  | ○   | ○   | ○   | X   |
| Auto.A      |          | ○  | X  | X  | ○  | X  | X  | ○  | ○  | ○  | ○   | X   | X   | X   |
| Auto.b      |          | X  | X  | X  | X  | X  | X  | ○  | ○  | ○  | ○   | X   | X   | X   |
| mEmo        |          | X  | X  | X  | X  | X  | X  | X  | X  | X  | X   | X   | X   | ○   |

※ "○" : IN-b sensor will be set as nPnhF or PnPhF in mode F11, F12, F13.

### Parameter 2 group

| Parameter 2     | Sub mode | F1 | F2 | F3 | F4 | F5 | F6 | F7 | F8 | F9 | F10 | F11 | F12 | F13 |
|-----------------|----------|----|----|----|----|----|----|----|----|----|-----|-----|-----|-----|
| dot             |          | ○  | ○  | X  | X  | X  | X  | ○  | ○  | ○  | ○   | ○   | ○   | ○   |
| t.unt           |          | X  | X  | ○  | ○  | ○  | ○  | X  | X  | X  | X   | X   | X   | X   |
| PSt. h          |          | ○  | ○  | ○  | ○  | ○  | ○  | ○  | ○  | ○  | ○   | ○   | ○   | ○   |
| PSt. L          |          | ○  | ○  | ○  | ○  | ○  | ○  | ○  | ○  | ○  | ○   | ○   | ○   | ○   |
| PSC.A.X (Note1) |          | ○  | ○  | X  | ○  | X  | X  | ○  | ○  | ○  | ○   | ○   | ○   | ○   |
| PSC.A.y (Note1) |          | ○  | ○  | X  | ○  | X  | X  | ○  | ○  | ○  | ○   | ○   | ○   | ○   |
| PSC.b.X         |          | X  | X  | X  | X  | X  | X  | ○  | ○  | ○  | ○   | X   | X   | X   |
| PSC.b.y         |          | X  | X  | X  | X  | X  | X  | ○  | ○  | ○  | ○   | X   | X   | X   |
| dISP.t          |          | ○  | X  | X  | X  | X  | X  | ○  | ○  | ○  | ○   | X   | X   | X   |

※ (Note1)PSC. X, PSC. y are displayed in mode F1, F2, F4, F11, F12, F13.

### Parameter 3 group

| Parameter 3 | Sub mode | F1 | F2 | F3 | F4 | F5 | F6 | F7 | F8 | F9 | F10 | F11 | F12 | F13 |
|-------------|----------|----|----|----|----|----|----|----|----|----|-----|-----|-----|-----|
| LoC         |          | ○  | ○  | ○  | ○  | ○  | ○  | ○  | ○  | ○  | ○   | ○   | ○   | ○   |

### Monitoring delay function operation chart by each output mode

|   | out-t | StAr.d | out-h | out-L | out-b | out-l | out-F |
|---|-------|--------|-------|-------|-------|-------|-------|
| Comparative output adjustment function. | ○     |        | X     | X     | ○     | X     | ○     |
| Starting correction timer function      | ○     | ○      | ○     | ○     | ○     | ○     | ○     |

## Parameter

### Parameter 0 group

| Menu and Parameter display | Parameter                                      | Setting range   | Setting key   |
|----------------------------|--|---|---|
|                            | Set H comparative value                        | ● F1, F2, F7, F9, F11, F12, F13 : 0 to 99999                        | ◀ : Move the setting digit<br>▼, ▲ : Change the setting value<br>MD : Fix and move to the next parameter  |
|                            | Set L comparative value                        | ● F3 to F6 : 0 to Setting time range<br>● F8, F10 : -19999 to 99999 |   |
|                            | Display high peak value among measuring values |   | ● Reset<br>If you press ◀ key for 2sec. while h.PEK or L.PEK is flickering, the peak value display will be reset to the current measuring value and it will keep flickering.<br>MD If you touch once again, it will return to L.PEK or RUN. |
|                            | Display low peak value among measuring values  |   |   |

※ When entering into parameter 0 group, the parameter name and data will be flickering by 1 sec, then move setting digit by ◀ key or change the setting value by ▼, ▲ key.

※ All data set by users will be shown [displayed] to 1 sec. cycle then move to the next parameter by pressing MD key.

※ (★1) If you press MD key in RUN mode, it will enter into PSt. h at comparative output mode and h.PEK at indication type. (PSt. parameter will not be displayed)

※ If pressing MD key for over 2sec. in every setting mode, data will be set and return to RUN and if you don't use the key for 60sec., data will be remained and return to RUN.

### Parameter 1 group

| Menu and Parameter display | Parameter   | Setting range  | Setting key  |
|----------------------------|---|--|--|
|                            | This is parameter 1 group.  |  |  |
|                            | Select operation mode.  | F1 to F13  | ▼, ▲ : Change the [F1 → F2 to F13] setting mode<br>MD : Fix and move to the next parameter   |
|                            | Set the sensor type of input A.   | <ul style="list-style-type: none"> <li>PNP transistor output type : PnPhF</li> <li>Contact output type (L output) : PnPLF</li> <li>NPN transistor output type : nPnhF</li> <li>Contact output type (H output) : nPnLF</li> </ul> | ▼, ▲ : Change the sensor type<br>MD : Fix and move to the next parameter   |
|                            | Set the sensor type of input B.   |  | MD : Fix and move to the next parameter  |
|                            | Select the output mode.   | StAr.d / out-h / out-L<br>out-b / out-l / out-F  | ▼, ▲ : Change the setting mode<br>[StAr.d → out-h → out-L<br>out-F → out-l → out-b]<br>MD : Fix and move to the next parameter   |
|                            | Set the hysteresis for the output. (★1)   | 0 to 9999 (If decimal point is set in 00000, the range will be 00 to 9999.)  | ◀ : Move the setting digit<br>▼, ▲ : Change the setting value<br>MD : Fix and move to the next parameter   |
|                            | Select the start compensating timer function or comparative output(L) limit function. (★2)              | ① F.dEFY / StAr.t<br>② When select StAr.t When [StAr.t] is flickering by 1sec. cycle, set the starting correction time 00 to 999   | ① ▼, ▲ : Change the setting mode<br>[F.dEFY → StAr.t]<br>MD : Fix and move to the next parameter<br>② ◀ : Move the setting digit<br>▼, ▲ : Change the setting value<br>MD : Fix and move to the next parameter |
|                            | Set the Auto-zero time of INA input.  |  | ◀ : Move the setting digit<br>▼, ▲ : Change the setting value<br>MD : Fix and move to the next parameter   |
|                            | Set the Auto-zero of INB input.   | 0.1 to 99999   | ◀ : Move the setting digit<br>▼, ▲ : Change the setting value<br>MD : Fix and move to the next parameter   |
|                            | It sets the memory retention. The measuring value will be memorized when the power off. (Mode F13 only) | on : Memory retention<br>off : No memory retention   | ▼, ▲ : Change the setting mode<br>[on → off]<br>MD : Fix and move to the next parameter nodE.  |

※ If you press MD key for 3 sec. in RUN, it will enter into parameter 1 group.

※ When entering into parameter 0 group, the parameter name and data will be flickering by 1 sec, then move setting digit by ◀ key or change the setting value by ▼, ▲ key.

※ The output mode is fixed as out-h type in F13 out-h operation mode.

※ (★1) Hysteresis is able to be set in F1, F7 to F10 operation mode. If you select one shot output mode [out-f], then [hyS] parameter will not be displayed.

※ (★2) It is able to select the comparative output [F.dEFY] limit function or starting correction [StAr.t] timer in monitoring delay function mode [GuAr.d].

When select the comparative output limit [F.dEFY] function, it will move to the next parameter [Auto.A] and when select the starting correction time [StAr.t] you need to be set the starting correction time [00 ~ 999] so that it moves to the next parameter [Auto.A].

※ All data set by users will be shown [displayed] to 1 sec. cycle then move to the next parameter by pressing MD key.

※ If press MD key for over 2 sec. in every setting mode, data will be set and return to RUN and if you don't use the key for 60 sec. data will be remained and return to RUN.

※ [ ] parameter is not shown in MP5M-4N.

## Parameter 2 group

| Menu and Parameter display  | Parameter  | Setting range   | Setting key  |     |           |           |           |           |       |        |         |         |            |         |       |       |          |          |   |
|---|--|---|--|-----|-----------|-----------|-----------|-----------|-------|--------|---------|---------|------------|---------|-------|-------|----------|----------|---|
| <p>MD press 4sec. RUN</p> <p>Display <b>PR-R.2</b> for 2sec. then advance to <b>dot</b> automatically pressing MD key before 1sec. it will move to <b>dot</b>.</p> <p>MD (★1)</p> <p>dot 00000</p> <p>t.unt t.5EC t.nIn</p> <p>① Select the time unit<br/>② Select the time range</p> | <p>This is parameter 2 group.</p> <p>Set decimal point position of display value</p> <p>It will be displayed in F3, F4, F5, F6 operation mode and set the time unit. (★1)</p> <p>① Select the time unit<br/>② Select the time range</p>  | <p>00000 00.000<br/>0000.0 0.0000<br/>0000.0 0.0000</p> <table border="1"> <thead> <tr> <th>SEC</th> <th>MIN</th> </tr> </thead> <tbody> <tr> <td>999.99sec</td> <td>999.99min</td> </tr> <tr> <td>9999.9sec</td> <td>9999.9min</td> </tr> <tr> <td>99min</td> <td>99hour</td> </tr> <tr> <td>59.9sec</td> <td>59.9min</td> </tr> <tr> <td>9hour59min</td> <td>999hour</td> </tr> <tr> <td>59sec</td> <td>59min</td> </tr> <tr> <td>99999sec</td> <td>99999min</td> </tr> </tbody> </table> | SEC  | MIN | 999.99sec | 999.99min | 9999.9sec | 9999.9min | 99min | 99hour | 59.9sec | 59.9min | 9hour59min | 999hour | 59sec | 59min | 99999sec | 99999min | <p>◀ : Move the decimal point<br/>MD : Fix and move to the next parameter</p> <p>① ▼, ▲ : Change the setting value<br/>MD : Save</p> <p>② ▼, ▲ : Change the setting value<br/>MD : Fix and move to the next parameter</p> |
| SEC   | MIN  |   |  |     |           |           |           |           |       |        |         |         |            |         |       |       |          |          |   |
| 999.99sec   | 999.99min  |   |  |     |           |           |           |           |       |        |         |         |            |         |       |       |          |          |   |
| 9999.9sec   | 9999.9min  |   |  |     |           |           |           |           |       |        |         |         |            |         |       |       |          |          |   |
| 99min   | 99hour   |   |  |     |           |           |           |           |       |        |         |         |            |         |       |       |          |          |   |
| 59.9sec   | 59.9min  |   |  |     |           |           |           |           |       |        |         |         |            |         |       |       |          |          |   |
| 9hour59min  | 999hour  |   |  |     |           |           |           |           |       |        |         |         |            |         |       |       |          |          |   |
| 59sec   | 59min  |   |  |     |           |           |           |           |       |        |         |         |            |         |       |       |          |          |   |
| 99999sec  | 99999min   |   |  |     |           |           |           |           |       |        |         |         |            |         |       |       |          |          |   |
| <p>PSt.h 99999</p> <p>PSt.L 00000</p> <p>PSC.RH 1.0000</p> <p>PSC.RY 10 00</p> <p>PSC.bH 1.0000</p> <p>PSC.bY 10 00</p> <p>dI SPt 0.05</p>  | <p>Set the comparative value H.</p> <p>Set the comparative value L.</p> <p>Set the prescale value of input A mantissa(X).</p> <p>Set the prescale value of input A an exponent(y).</p> <p>Set the prescale value of input B mantissa(X).</p> <p>Set the prescale value of input B an exponent(y).</p> <p>Select the display cycle.</p> | <p>●F1, F2, F7, F9, F11, F12, F13 : 0 to 99999<br/>●F3 to F6 : 0 to Setting time range<br/>●F8, F10 : -19999 to 99999</p> <p>00000 to 9.9999</p> <p>10<sup>-9</sup> to 10<sup>9</sup><br/>(10<sup>-9</sup> to 10<sup>9</sup>)</p> <p>0.0000 to 9.9999</p> <p>10<sup>-9</sup> to 10<sup>9</sup><br/>(10<sup>-9</sup> to 10<sup>9</sup>)</p> <p>0.05, 0.5, 1, 2, 4, 8</p>   | <p>◀ : Move the setting digit<br/>▼, ▲ : Change the setting value<br/>MD : Fix and move to the next parameter</p> <p>◀ : Move the setting digit<br/>▼, ▲ : Change the setting value<br/>MD : Fix and move to the next parameter</p> <p>◀ : Move the setting digit<br/>▼, ▲ : Change the setting value<br/>MD : Fix and move to the next parameter</p> <p>◀ : Move the setting digit<br/>▼, ▲ : Change the setting value<br/>MD : Fix and move to the next parameter</p> <p>◀ : Move the setting digit<br/>▼, ▲ : Change the setting value<br/>MD : Fix and move to the next parameter</p> <p>▼, ▲ : Change the setting value<br/>MD : Fix and move to the next parameter</p> |     |           |           |           |           |       |        |         |         |            |         |       |       |          |          |   |

※ If press MD key for 4 sec. in RUN, it will enter parameter 2 group.

※ (★1) It will enable to select the time until as sec. [t.5EC] or min. [t.nIn] in t.unt parameter. Select the time range after selecting the time unit as sec. [t.5EC] or min. [t.nIn]

※ When entering into the parameter 2 group, the parameter name and data value will be flickering by 1 sec then, move the setting digit by ◀ key and change the setting value by ▼, ▲ key.

※ The fixed data value set by user in each parameter will flicker by cycle (1 sec.) and move to the next parameter by pressing MD key.

※ If press MD key for over 2 sec. in every setting mode, data will be set and return to RUN then if no key is touched for 60 sec., data will be held as previous value and return to RUN mode.

※ [ ] parameter is not shown in MP5S-4N.

## Parameter 3 group

| Menu and Parameter display  | Parameter  | Setting range   | Setting key  |
|---|--|---|--|
| <p>MD press 5sec. RUN</p> <p>MD press 2sec.</p> <p>Display <b>PR-R.3</b> for 2sec. then move to <b>F5-h</b> automatically. Move to <b>F5-h</b>, if press MD key before 1sec.</p> <p>MD</p> <p>LoC OFF</p> | <p>This is parameter 3 group.</p> <p>Enable to lock the key for each parameter group</p> | <p>oFF : There is no key lock in all mode<br/>LoC.0 : P0 to 3 Lock<br/>LoC.1 : P1 to 3 Lock<br/>LoC.2 : P2 to 3 Lock<br/>LoC.3 : P3 Lock only</p> | <p>▼, ▲ : Change the setting mode<br/>oFF → LoC.0 → LoC.1<br/>LoC.3 ← LoC.2</p> <p>MD : If pressing MD key for over 2sec., data will be set and it will return to RUN.</p> |

※ If press MD key for 5 sec. in RUN, it will enter into parameter 3 group.

※ When entering into the parameter 3 group, the parameter name and data value will flicker by cycle (1 sec.) then change the value by one touching setting value alteration ▼, ▲ key.

※ The fixed data value by user in each parameter will flicker by cycle (1 sec.) and if press MD key for over 2 sec., data will be set and return to RUN mode then if no key is touched for 60 sec., data will be held as previous value and return to RUN mode.

## Function

### Prescale function

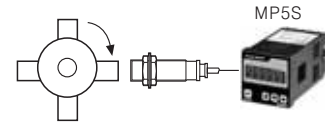

$$\begin{aligned} \text{rpm} &= f \times \alpha \\ &= f \times 60 \times (1 / N) \\ &= f \times 60 \times (1 / 4) \\ &= f \times 60 \times 0.25 \\ &= f \times 15 \\ \text{※ } f &: \text{Input pulse(Frequency) per sec. [Hz]} \\ N &: \text{Pulse number per 1 revolution} \end{aligned}$$

● How to set prescale value (α=15)  
Set prescale value (α) to separate as a mantissa(X) and an exponent(Y) at PSC.RH, PSC.RY (or PSC.bH, PSC.bY) of Parameter 2 group.  
Prescale value (α)=15, a Mantissa(X):1.5000, Exponent(y):10<sup>1</sup>. And also it is able to set α value as X=0.015, Y=10<sup>3</sup> then get the same display value.  
※ Display cycle can be selected at parameter 2 group.

### Display peak value monitoring function

This is to monitor max. value and min. value by current display value and display that data at hPEP/LPEP mode of parameter 0 group.  
● User can check saved value in parameter 0 group. And high peak(hPEP) or low peak(LPEP) will be continuously saved during checking.  
● See parameter 0 for reset.

### Hysteresis function

Set the Hysteresis value(A) for comparative setting value in order to prevent unstable operation due to output going ON/OFF frequently.

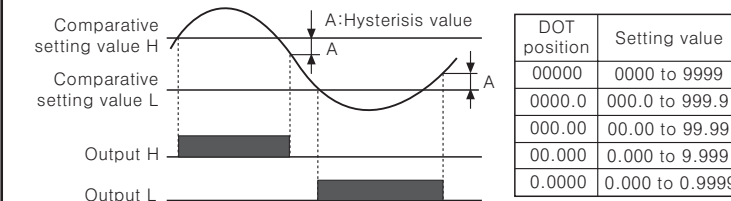

※ You are able to set "0", but when set "0", the actual operation will be as "1".  
※ The initial setting value is 0001.  
※ You are able to set in the parameter 1 group.

### Monitoring delay time function

This function is for the stable control to limit L, LL outputs until certain output is come or to limit all outputs during the equipment is reaching a stable status against various change of input such as the starting current when the motor is running after power on. There are the starting correction timer function and comparative output limit function in the monitoring delay function. (Select at CuAr.d mode of parameter 1 group)  
● The starting correction timer function (StAr.t mode of parameter 1 group)  
This function is to make the output not come out during the setting time. (Time setting range 0.0 to 99.9sec.)

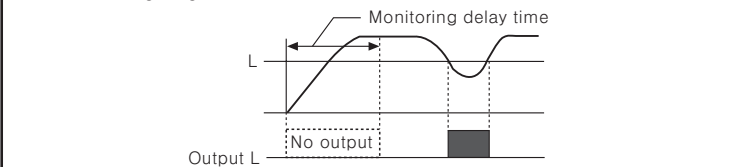

### Comparative output limit function (FdEFY mode of parameter 1 group)

This function is to limit the L output before the H output of S, B, F output mode.

1) The output mode is S output mode, B output mode

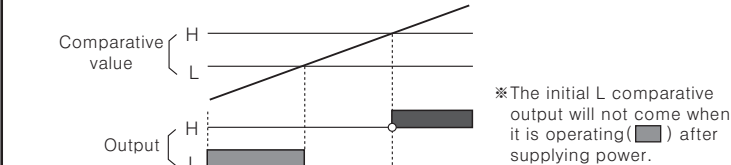

2) The output mode is F output mode

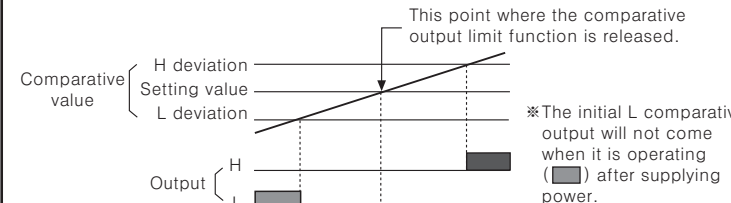

※ The output mode is F output mode, the comparative output limit function will be released at the setting value (Standard setting).  
※ H deviation setting value > L deviation setting value, H deviation setting value < L deviation setting value

### Auto-Zero time setting function

When you know the interval of input signal, Auto-zero time should be set as a little bit longer than that interval of input signal. If there is no pulse input within setting time (Auto-zero time), it regards as the input signal is cut off then make the value as "00000" forcibly. Note that the Auto-zero time setting should be longer than the narrowest interval of input pulse. Otherwise it may be difficult to make the display value as "00000".

● Auto-zero time setting range (0.1 to 9999.9sec)

● When the display value is "00000", each output will be come against "0".

● Auto-zero time setting is available in parameter 1 group.

### Lock setting function

This function is to set the enable or disable of each parameter and mode changes in MP5M.

- Off : Unlock
- LoC 0 : P0 to P3 Lock (Lock from parameter 0 to parameter 3)
- LoC 1 : P1 to P3 Lock (Lock from parameter 1 to parameter 3)
- LoC 2 : P2 to P3 Lock (Lock from parameter 2 to parameter 3)
- LoC 3 : P3 Lock (Lock parameter 3 only)
- ※ Lock setting is available in parameter 3 group.

### Inner hardware lock setting function

This function is to lock LoC in parameter 3 group by Inner hardware lock function in order to prevent wrong setting.

- h0 (Hardware Lock0) : Enable to check and change the LoC mode of parameter 3 group.
- h1 (Hardware Lock1) : Enable to check the LoC mode only in parameter 3 group. But it is not possible to change the parameter.
- h2 (Hardware Lock2) : Disable to check and change the LoC mode of parameter 3 group.
- It is possible to lock or unlock after supplied power in Inner hardware lock setting.

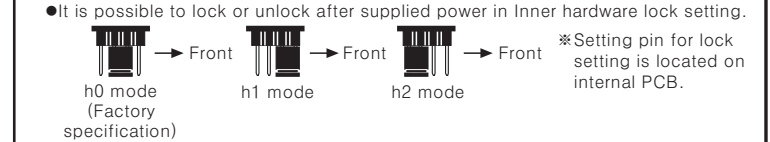

### Display cycle selection function

This function is to change the display cycle in range of 0.05/0.5/1/2/4/8 sec., and displays the average value of measuring value for the setting cycle.

### Time unit selection function

Enable to display PV value with firmed time unit in range of various time.

● Time unit selection function can be set in parameter 2 group.

● Applicable mode : Mode 3 to 6

※ There is no DOT setting mode when set the time unit display function.

### Factory default

| Parameter 3 group |               | Parameter 2 group |               | Parameter 1 group |               |
|-------------------|---------------|-------------------|---------------|-------------------|---------------|
| Mode              | Setting value | Mode              | Setting value | Mode              | Setting value |
| LoC               | oFF           | dot               | 00000         | PSt. h            | 5.0000        |
|                   |               | PSt. L            | 99999         | PSt. y            | 10 01         |
|                   |               | PSt. L            | 00000         | dI SPt            | 0.05          |

※ The specification may not be displayed due to the operation mode and output specification.

## Caution for using

- Installation environment
  - It shall be used indoor
  - Altitude Max. 2000m
  - Pollution Degree 2
  - Installation Category II.
- Please use separated line from high voltage line or power line in order to avoid inductive noise.
- Please install power switch or circuit breaker in order to cut the power supply.
- The switch or circuit breaker should be installed near by users for safety.
- Do not use this unit at below places.
  - Place where there are severe vibration or impact.
  - Place where there are direct ray of the sun.
  - Place where strong magnetic field or electric noise are generated.
- Storage method  
When storing this unit for a long time, please avoid the direct ray of the sun and keep this unit under circumstances as -20 to +60°C, 35 to 85RH.
- Input line : Shield wire must be used when the measuring input line is getting longer or there are lots of noises.
- Please put enough space between power line and terminal of measuring input.

※ It may cause malfunction if above instructions are not followed.

## Main products

- COUNTER
- TIMER
- TEMPERATURE CONTROLLER
- PANEL METER
- TACHO/LINE SPEED/ PULSE METER
- DISPLAY UNIT
- PROXIMITY SENSOR
- PHOTOELECTRIC SENSOR
- FIBER OPTIC SENSOR
- PRESSURE SENSOR
- ROTARY ENCODER
- SENSOR CONTROLLER
- POWER CONTROLLER
- STEPPING MOTOR & DRIVER
- LASER MARKING SYSTEM

**Autonics Corporation**  
http://www.autonics.net

HEAD QUARTER :  
41-5, Yongdang-ri, Ulsang-eup, Yangsan-si, Gyeongnam, Korea 626-847

INTERNATIONAL SALES :  
512 Ansung B/D, 410-13, Shindorim-dong, Guro-gu, Seoul, Korea 152-070  
TEL: 82-2-2679-6585 / FAX: 82-2-2679-6556  
E-mail : sales@autonics.net