

THD Series

Indoor, Duct & Wall mounting type Temperature/Humidity transducer

Features

- Compact design
- Built-in temp./humidity sensor
- 7 Segment LED Display (THD-DD/THD-WD)
- Various output modes
DC4-20mA, 1-5VDC, RS485 (MODBUS RTU)
- Wide range of temp./humidity measurement
-19.9 ~ 60.0°C / 0.0 ~ 99.9%RH
- Communication speed : 115200bps

⚠ Please read "Caution for your safety" in operation manual before using.

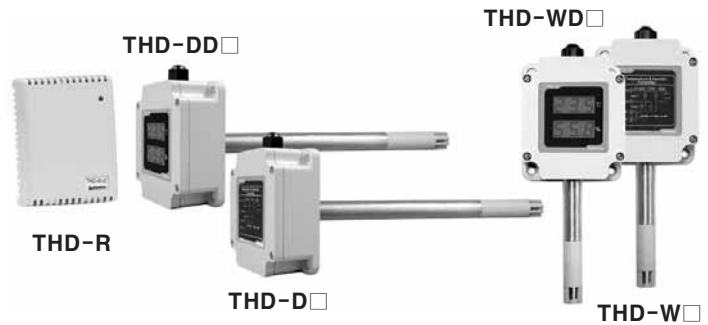

Ordering information

THD - D D 1 - C

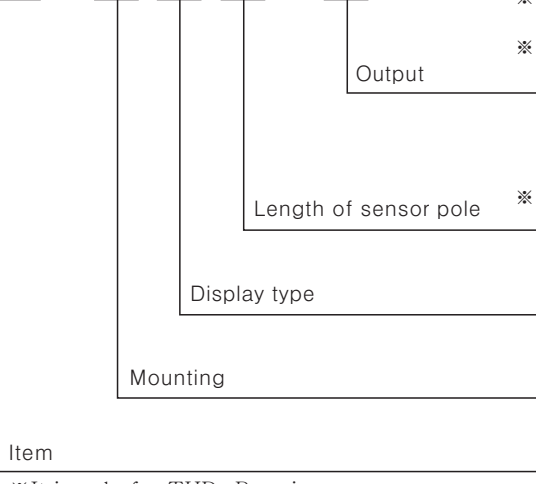

※ PT	Temperature sensor resistance value (PT100Ω)
※ PT/C	Temperature sensor resistance value (PT100Ω) / Current output (DC4-20mA)
C	Current output (DC4-20mA)
V	Voltage output (1-5VDC)
T	RS485 communication output (MODBUS RTU)
※	Built-in
1	100mm
2	200mm
	Non-Display
D	Display
R	Room (For indoor)
D	Duct mounting
W	Wall mounting
THD	Temperature Humidity Double

※ It is only for THD-R series.

Specifications

Model	THD-R-PT	THD-R-PT/C	THD-R-□	THD-D□-□ THD-W□-□	THD-DD□-□ THD-WD□-□
Display type	—	Non-indicating type			7 Segment LED Display
Digit	—	—			3 Digit for temperature, humidity
Character size	—	—			10mm
Power supply	—	24VDC ± 10%			
Power consumption	—	Max. 2.4W			
Measuring input	Temperature (Built-in sensor)	Temperature, Humidity (Built-in sensor)			
Output	Temp.	PT100Ω resistance value	● DC4-20mA ● 1-5VDC ● RS485 (MODBUS RTU)		
	Humidity	—	DC4-20mA	—	
Measurement range	Temp.	-19.9~60.0°C			
	Humidity	—	0.0~99.9%RH (THD-R series is required to attend for using over 90%RH.)		
Accuracy	Temp.	Max. ±0.8°C	-19.9~5.0°C : Max. ±1.0°C, 5.0~40.0°C : Max. ±0.5°C, 40.0~60.0°C : Max. 1.0°C		
	Humidity	—	Max. ±3%RH at 30~70%RH (at 25~45°C)		

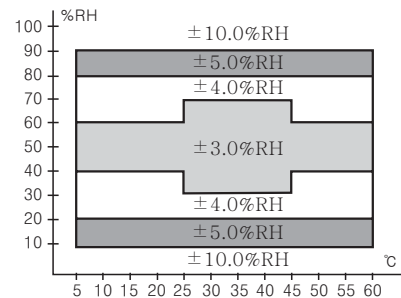

Temperature/Humidity Transducer

Specifications

Model	THD-R-PT	THD-R-PT/C	THD-R-□	THD-D□-□ THD-W□-□	THD-DD□-□ THD-WD□-□
Sampling period	————	————	————	Fixed 0.5sec	
Insulation resistance	————	————	————	Min. 100MΩ (500VDC mega)	
Dielectric strength	————	————	————	500VAC 50/60Hz for 1 minute	
Noise strength	————	————	————	±0.3kV the square wave noise (pulse width:1μs) by the noise simulator	
Vibration	Mechanical	————	————	0.75mm amplitude at frequency of 10~55Hz in each of X, Y, Z directions for 1hour	
	Malfunction	————	————	0.5mm amplitude at frequency of 10~55Hz in each of X, Y, Z directions for 10minutes	
Shock	Mechanical	————	————	300m/s ² (30G) in X, Y, Z directions for 3 times	
	Malfunction	————	————	100m/s ² (10G) in X, Y, Z directions for 3 times	
Protection	IP10			IP65 (Except sensing part.)	
Ambient temperature	-20 ~ 60℃ (at non-freezing status)				
Storage temperature	-20 ~ 60℃ (at non-freezing status)				
Cable	Terminal type			4P, φ 4mm, Length:2m	
Unit weight	Approx. 55g			Approx. 160g	

*The allowable impedance of current output is max. 600Ω

Dimensions

- THD-R-□ ●THD-R-PT ●THD-R-PT/C

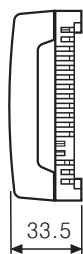
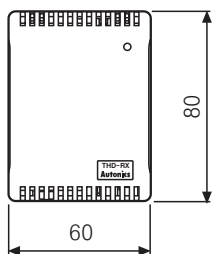

*Mounting part

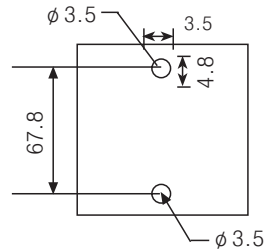

(Unit:mm)

- THD-D□-□ / THD-DD□-□ ●THD-W□-□ / THD-WD□-□

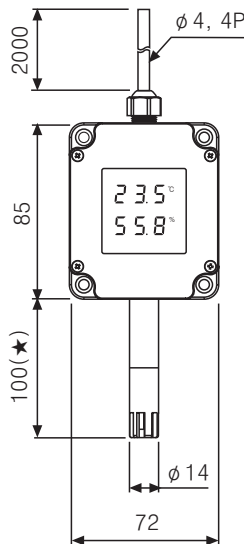
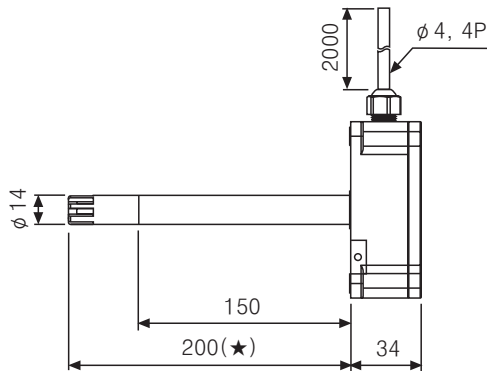

*Mounting part

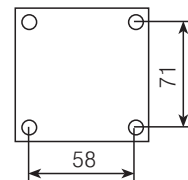

*(★) See the ordering information to select the one with 2 sensing poles.

*See the ordering information about display model, THD-DD□-□, THD-WD□-□.

Connections

- THD-R Series

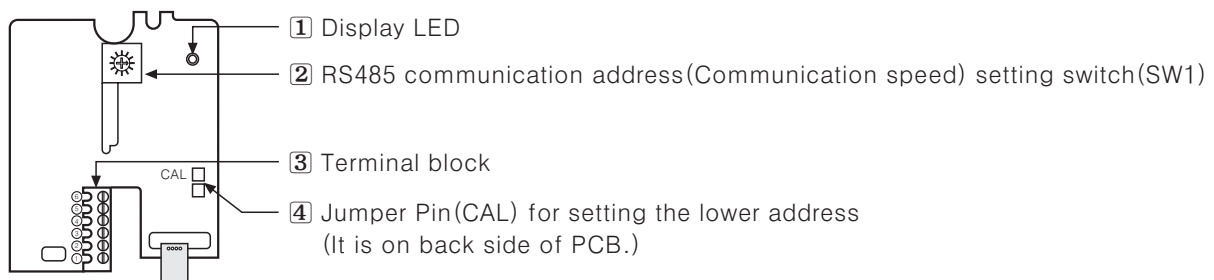

(A) Counter

(B) Timer

(C) Temp. controller

(D) Power controller

(E) Panel meter

(F) Tacho/ Speed/ Pulse meter

(G) Display unit

(H) Sensor controller

(I) Switching power supply

(J) Proximity sensor

(K) Photo electric sensor

(L) Pressure sensor

(M) Rotary encoder

(N) Stepping motor & Driver & Controller

(O) Graphic panel

(P) Field network device

(Q) Production stoppage models & replacement

THD Series

●THD-R-PT/C

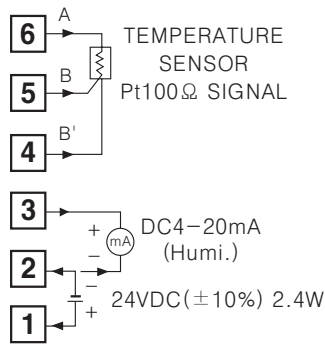

●THD-R-C, V, T

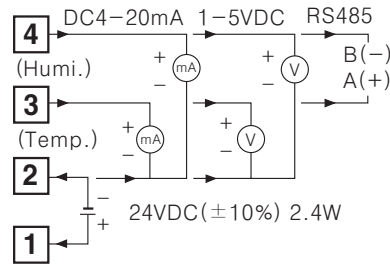

●THD-R-PT

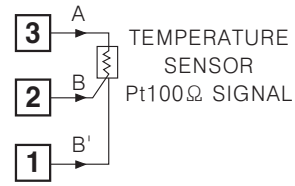

※Please note the terminal connection and be careful with power supply.

◎THD-D / THD-W Series

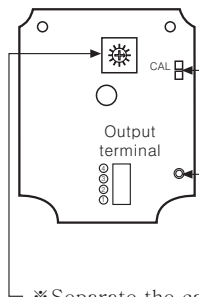

●Current output type

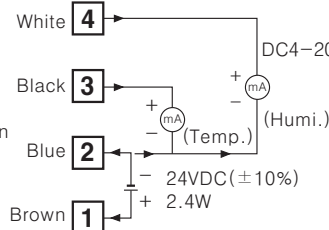

●Voltage output type

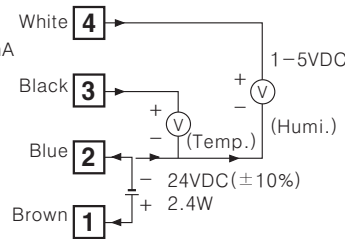

●Communication output type

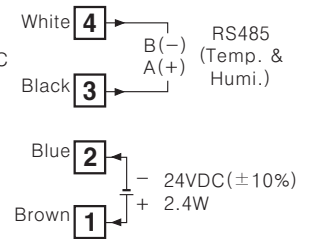

※Separate the case cover only in case of setting communication, set the unit code, communication speed using communication setting switch.

■Case detachment

●THD-R Series

Unscrew the bolt on the bottom of product and separate the case.

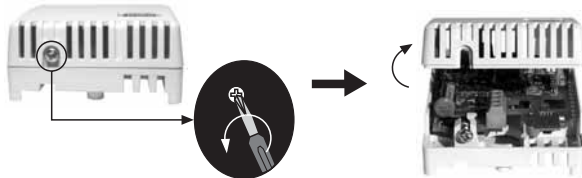

●THD-D / THD-W Series

Unscrew 4 bolts on the top of product and separate the case.

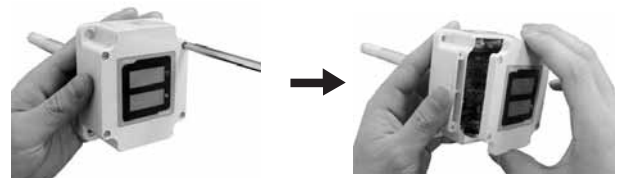

■Functions

◎Voltage output

It transmits current temperature/humidity to other equipments, PC or recorder and outputs 1-5VDC. 1VDC output represents -19.9°C of temperature and 0.0% RH of humidity, 5VDC at 60°C of temperature and 99.9% RH of humidity. The temperature and humidity output are separated and the resolution is divided as 1,000.

◎Current output

It transmits current temperature/humidity to other equipments, PC or recorder and outputs DC4-20mA. It outputs DC4mA at -19.9°C of temperature and 0.0%RH of humidity, DC20mA at 60.0°C of temperature and 99.9%RH of humidity. The temperature and humidity output are separated and the resolution divisible by 1,000.

◎Temperature sensor output(Pt 100Ω resistance value output)

It transmits current temperature/humidity to other equipments, recorder or thermometer. It outputs 100Ω at 0°C and 119.40Ω at 50°C . (TCR=3850 ppm/ $^{\circ}\text{C}$)

Temperature/Humidity Transducer

- (A) Counter
- (B) Timer
- (C) Temp. controller
- (D) Power controller
- (E) Panel meter
- (F) Tacho/ Speed/ Pulse meter
- (G) Display unit
- (H) Sensor controller
- (I) Switching power supply
- (J) Proximity sensor
- (K) Photo electric sensor
- (L) Pressure sensor
- (M) Rotary encoder
- (N) Stepping motor & Driver & Controller
- (O) Graphic panel
- (P) Field network device
- (Q) Production stoppage models & replacement

◎RS485 communication output

It is used to transmit current temperature and humidity to other equipment.

●Interface

Standard	EIA RS485
Number of connections	31, It is available to set address 01~31
Communication method	Half Duplex
Synchronous method	Asynchronous type
Communication distance	Within max. 800m
Communication speed	1200 ~ 115200bps(Available to set)
Start bit	1bit(Fixed)
Stop bit	1bit(Fixed)
Parity bit	None(Fixed)
Data bit	8bit(Fixed)
Protocol	MODBUS RTU

- ※It is not possible to change parameter related to communication of THD under the communication with high order system.
- ※Match the parameter of THD communication to be same as the high order system.
- ※It is not allowed to set overlapping communication address at the same communication line.
- ※Please use a proper twist pair for RS485 communication.

●Application of system organization

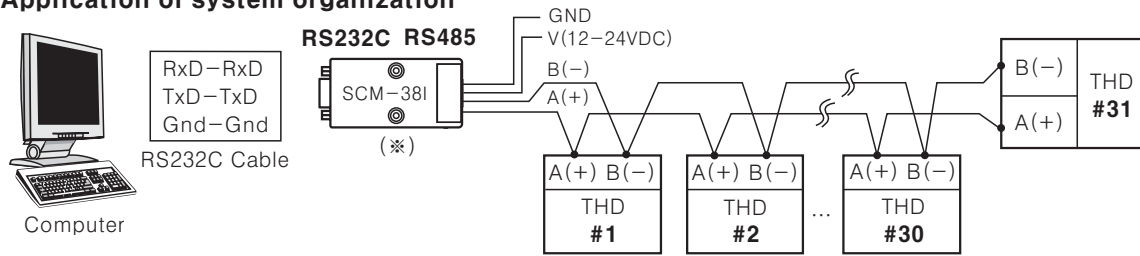

※SCM-38I made by Autonics is recommended to use with RS232C to RS485 converter.

◎Communication control ordering

- The communication method is MODBUS TRU(PI-MBUS-300 REV.J).
- After 0.5sec of power supply into the high order system, it starts to communicate.
- Initial communication will be started by the high order system. When a command comes out from the high order system, THD will respond.

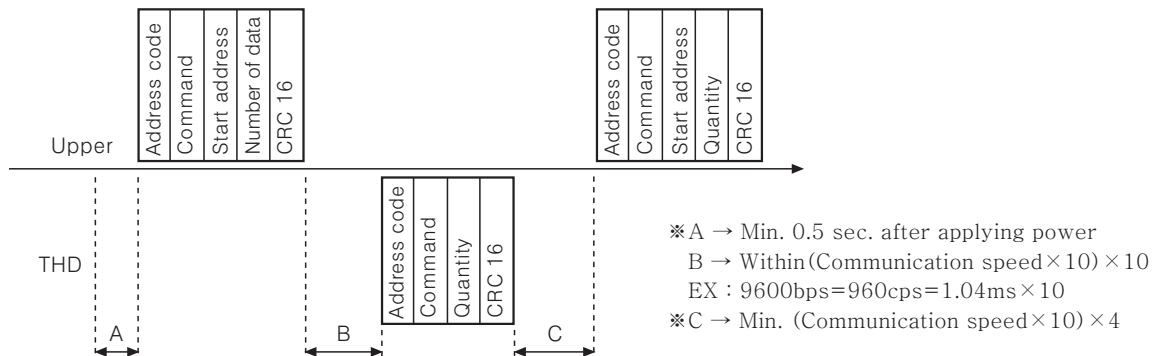

●Communication command and block

The format of query and response

Query

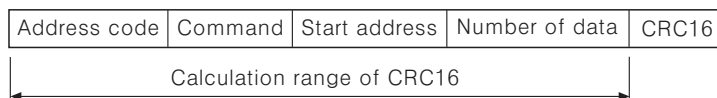

- ①Address code : This code which the high order system can identify THD by. It can be set within range 01H-1FH.
- ②Command : Read command for input register.
- ③Start address : The start address of input register to read (Start address), it is available to select 0000 and 0001 for start address. 16 bit data in the address 0000 indicates temperature value, 16 bit data in the address 0001 indicates humidity value.(Refer to MODBUS Mapping table.)
- ④Number of data : The number of 16 bit data from start address(No. of Points) It reads 2 of 16 bit data when start address is 0000 or reads 1 of 16 bit data is available when start address is 0001.
- ⑤CRC16 : Check Sum which checks the whole frame and it is used for more reliable transmit/receive to check the error between transmitter and receiver.

THD Series

Response

Address code	Command	Number of data	Temperature data	Humidity data	CRC16
Calculation range of CRC16					

- ①Address code : The code, W the high order system can identify THD by. It can be set within range 01H-1FH.
- ②Command : Read command for input register.
- ③Number of data : The number of 8 bit data to send from start address(No. of Bytes)
It reads 4 of 8 bit data when start address is 0000 or reads 2 of 8 bit data is available when start address is 0001.
(Refer to MODBUS Mapping Table)
- ④Temperature data : To get a current temperature value, divide read value by 100.
Ex) When read data is 0x09B6, decimal value 2486, the current value is 2486/100=24.86℃.
- ⑤Humidity data : To get a current humidity value, divide read value by 100.
Ex) When read data is 0x12FE, decimal value 4862, the current value is 4862/100=48.62%RH.
- ⑥CRC16 : Check Sum which checks the whole frame.(Refer to E-34 for CRC16 Table.)

●Application

(Query) : Address code(01), Start address(0000), The number of 16 Bit data to read(2) Check Sum(0x71CB)

01	04	00	00	00	02	71	CB
Unit number	Command	Start code		Amount of data		CRC16	
		High order	Low order	High order	Low order	High order	Low order

(Response) : Address code(01), The number of 8 Bit data to read(4), Temperature(0x09B6), Humidity(0x12FE)
CRC Check sum(0x94DE)

01	04	04	09	B6	12	FE	94	DE
Unit number	Reponse command	Amount of data	Temperature data		Humidity data		CRC16	
			High order	Low order	High order	Low order	High order	Low order

●Error processing(Slave → Master)

1. Non-supportable command

01	81	01	81	90
Unit number	Response command	Exception code	CRC16	

※Set a received highest bit and send it to response command and exception code 01.

2. The start code of queried data is not matched to the transmittable code

01	81	02	81	90
Unit number	Response command	Exception code	CRC16	

※Set a received highest bit and send it to response command and exception code 02.

3. The number of queried data is bigger than transmittable one

01	84	03	X	X
Unit number	Response command	Exception code	CRC16	

※Set a received highest bit and send it to response command and exception code 03.

4. Abnormal processing for a received command

01	84	04	X	X
Unit number	Response command	Exception code	CRC16	

※Set a received highest bit and send it to response command and exception code 04.

◎Change the communication speed(THD-R Series)

- 1)Set SW1 to 0 and apply the power.
- 2)Operation LED is flashing.
- 3)Set a communication speed after choose SW1 within the range 1~8 and hold it for 3sec.
- 4)After set a communication speed, LED will be ON.
- ※Factory default communication speed is 9600bps(SW 1:4) for communication speed.
- ※In order to change the communication speed, please turn off the power and repeat step 1) ~ 4).
- ※Setting table of communication speed (bps).

SW1	Communication speed(BPS)
1	1200
2	2400
3	4800
4	9600
5	19200
6	38400
7	57600
8	115200

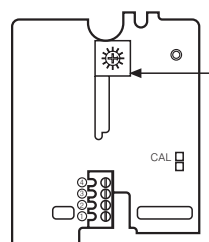

<Inner PCB of THD-R>

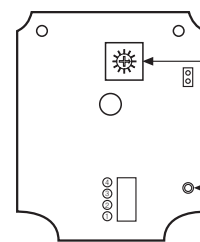

<Inner PCB of THD-D□, THD-W□>

Temperature/Humidity Transducer

◎Change the communication address(THD-R Series)

- 1) Set CAL Jump pin and SW1 at new address, apply the power.
- 2) The communication address is changed automatically.

※Factory default communication address is 01. (SW1 : 1, CAL Jump pin : Open)

※In order to change the communication address, please turn off the power and repeat step 1)~2).

※Setting table of communication address

CAL Pin	SW1	Add no.	CAL Pin	SW1	Add no.
OPEN	1	01	SHORT	0	16
OPEN	2	02	SHORT	1	17
OPEN	3	03	SHORT	2	18
OPEN	4	04	SHORT	3	19
OPEN	5	05	SHORT	4	20
OPEN	6	06	SHORT	5	21
OPEN	7	07	SHORT	6	22
OPEN	8	08	SHORT	7	23
OPEN	9	09	SHORT	8	24
OPEN	A	10	SHORT	9	25
OPEN	B	11	SHORT	A	26
OPEN	C	12	SHORT	B	27
OPEN	D	13	SHORT	C	28
OPEN	E	14	SHORT	D	29
OPEN	F	15	SHORT	E	30
-	-	-	SHORT	F	31

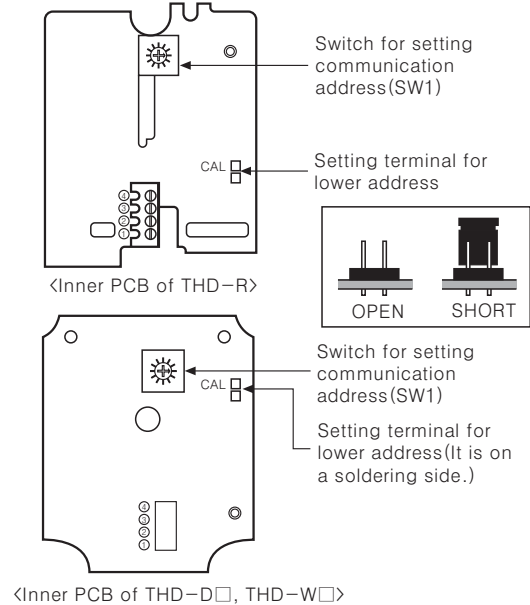

■Caution for using

1. After checking the input specification, terminal polarity, connect the wires correctly.
2. Do not connect a wire, examine and repair when the power is applying.
3. Do not touch the temperature/humidity sensor module.
4. Please use THD-R series as wall mounting type.
5. Caution for cleaning
 - ①Use dry towel
 - ②Do not use acid, chrome acid and solvent but alcohol.
 - ③Clean after turn off the power and turn it on 30 min. after.
6. Be sure that metal dust and wire-dregs are not flowed in the unit.
7. Connect the wires after checking polarity.
8. Please use separated line from high voltage line or power line in order to avoid inductive noise.
9. Keep away from the high frequency instruments. (High frequency welding machine & sewing machine, big capacitive SCR controller)
10. The switch or circuit breaker should be installed near by user for convenience.
11. Installation environment
 - ①It shall be used indoor
 - ②Altitude Max. 2000m
 - ③Pollution Degree 2
 - ④Installation Category II

(A)
Counter

(B)
Timer

(C)
Temp.
controller

(D)
Power
controller

(E)
Panel
meter

(F)
Tacho/
Speed/
Pulse
meter

(G)
Display
unit

(H)
Sensor
controller

(I)
Switching
power
supply

(J)
Proximity
sensor

(K)
Photo
electric
sensor

(L)
Pressure
sensor

(M)
Rotary
encoder

(N)
Stepping
motor &
Driver &
Controller

(O)
Graphic
panel

(P)
Field
network
device

(Q)
Production
stoppage
models &
replacement